

# STUDIO HENK

We are Studio HENK, a Dutch furniture design studio. Inspired by daily moments we design furniture for everyday life.

We believe that furniture design isn't just about creating a beautiful piece; it's about designing furniture for everyday use. Therefore, we make furniture pieces that are both aesthetic and functional. All pieces from our collection can be customised. That way, you can create a piece of furniture that is exactly what you need to enjoy your day-to-day life. Our collection consists of all the types of furniture you need for your living and dining space, office or restaurant.

# Table of content

## Dining Tables | rectangular

Oak	06
Walnut	08
HPL Fenix	10

## Dining Tables High | rectangular

Oak	12
Walnut	14
HPL Fenix	16

## Dining Tables | flat oval

Oak	18
Walnut	20
HPL Fenix	22

## Dining Tables High | flat oval

Oak	24
Walnut	26
HPL Fenix	28

## Dining Table | Slot

Flat Oval   Oak	30
Flat Oval   Walnut	30
Blob   Oak	32
Blob   Walnut	32
Round   Oak	34
Round   Walnut	34

## Dining Tables | oval

Oak	36
Walnut	38
HPL Fenix	40

## Dining Tables High | oval

Oak	42
Walnut	44
HPL Fenix	46

## Dining Tables | blob

Oak	48
Walnut	50
HPL Fenix	52

## Dining Tables | round

Oak	54
Walnut	56
HPL Fenix	58

## Amoeba Collection

60

## Home Desks

Oak	62
Walnut	64
HPL Fenix	66

## Bistro Tables

Oak	68
HPL Fenix	70

## Bistro Tables High

Oak	72
HPL Fenix	74

## Dining Benches | rectangular

Oak	76
Walnut	78
HPL Fenix	80

## Dining Benches | flat oval

Oak	82
Walnut	84
HPL Fenix	86

## Dining Bench | Slot

Oak	88
Walnut	88

## Dining Bench | Coode

90

## Dining Bench Cushions

92

# Table of content

## Coffee Tables | New Co

Oak	94
HPL Fenix	96

## Coffee Table | Slot

Oak	98
Walnut	98

## Coffee Table | Elements

Oak	100
-----	-----

## Coffee Table | Scissors

102

## Dining Chairs

Co Chair	104
Ode Chair	106
Base Chair	108
Oblique Chair	110

## Stools

Ode Bar Stool	112
Base Stool	114
Bolster Stool	116

## Cabinets

Modular Cabinet	118
Modular Cabinet Stand Alone	120
Oblique Cabinet	122

## Dressers

The Dresser	124
-------------	-----

## Sofas & Lounge Chairs

Co Lounge	126
Ode Lounge Without Armrests	128
Ode Lounge With Armrests	130
Luna Lounge	132
Base Lounge	134
Oblique Lounge	136
Lean Lounge	138
Modulo	140
Cube	146
Cave	152
Cosy	158
Layer	164

## Pouf

Otto	168
------	-----

## Lighting

Nod Collection	170
----------------	-----

## Outdoor Collection

Dining Tables	172
Dining Benches	174
Dining Bench Cushions	176
Coffee Tables	178
Sofas	178

## Upholstery Groups

182

## Finish Options

Wood	183
HPL Fenix	184
Steel	185
Edge	185

## How many chairs fit a dining table

Rectangular	186
Flat oval	189
Oval	191
Blob	193
Round	195

# Dining Tables | rectangular

Oak

standard



chamfered



Base (oak)



Butterfly



Co



Legno (oak)



New Classic



New Co



Slim Co



Slim X-type



Topple

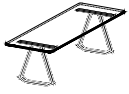

Cylinder (oak)



Flyta



Column

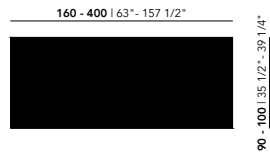

90 | 100 | 35 1/2\"/>

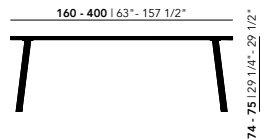

74 | 75 | 29 1/4\"/>

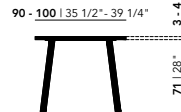

3 - 4 | 1 1/4\"/>

Tabletop

Oak | see all finish options on page 183

Frame

Steel | see all finish options on page 185

Oak | see all finish options on page 183

Length (cm)	Width (cm)	Thickness (cm)	Height (cm)
160	90	3	74
180	90	3	74
200	90	3	74
220	90	3	74
240	90	3	74
260	90	3	74
280	90	3	74
300	90	3	74
160	100	3	74
180	100	3	74
200	100	3	74
220	100	3	74
240	100	3	74
260	100	3	74
280	100	3	74
300	100	3	74
160	90	4	75
180	90	4	75
200	90	4	75
220	90	4	75
240	90	4	75
260	90	4	75
280	90	4	75
300	90	4	75
350	90	4	75
400	90	4	75
160	100	4	75
180	100	4	75
200	100	4	75
220	100	4	75
240	100	4	75
260	100	4	75
280	100	4	75
300	100	4	75
350	100	4	75
400	100	4	75

# Dining Tables | rectangular

Walnut

standard



chamfered



Butterfly

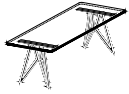

Co



New Classic

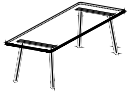

New Co



Slim Co



Slim X-type



Topple

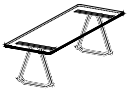

Flyta



Column

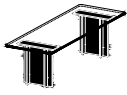

160 - 400 | 63" - 157 1/2"



90 - 100 | 35 1/2" - 39 1/4"

160 - 400 | 63" - 157 1/2"



74 - 75 | 29 1/4" - 29 1/2"

90 - 100 | 35 1/2" - 39 1/4"



3 - 4 | 1 1/4" - 1 1/2"

71 | 28"

Length (cm)	Width (cm)	Thickness (cm)	Height (cm)
160	90	3	74
180	90	3	74
200	90	3	74
220	90	3	74
240	90	3	74
260	90	3	74
280	90	3	74
300	90	3	74
160	100	3	74
180	100	3	74
200	100	3	74
220	100	3	74
240	100	3	74
260	100	3	74
280	100	3	74
300	100	3	74
160	90	4	75
180	90	4	75
200	90	4	75
220	90	4	75
240	90	4	75
260	90	4	75
280	90	4	75
300	90	4	75
350	90	4	75
400	90	4	75
160	100	4	75
180	100	4	75
200	100	4	75
220	100	4	75
240	100	4	75
260	100	4	75
280	100	4	75
300	100	4	75
350	100	4	75
400	100	4	75

Tabletop

Walnut | see all finish options on page 183

Frame

Steel | see all finish options on page 185

# Dining Tables | rectangular

HPL Fenix

standard



chamfered



Base (oak)



Butterfly



Co



Legno (oak)



New Classic



New Co



Slim Co



Slim X-type



Topple

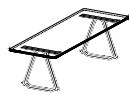

Cylinder (oak)



Flyta



160 - 400 | 63" - 157 1/2"



90 - 100 | 35 1/2" - 39 1/4"

160 - 400 | 63" - 157 1/2"

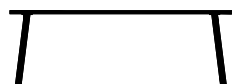

75 | 29 1/2"

90 - 100 | 35 1/2" - 39 1/4"



71 | 28"

Length (cm)	Width (cm)	Thickness (cm)	Height (cm)
160	90	4	75
180	90	4	75
200	90	4	75
220	90	4	75
240	90	4	75
260	90	4	75
280	90	4	75
300	90	4	75
350	90	4	75
400	90	4	75
160	100	4	75
180	100	4	75
200	100	4	75
220	100	4	75
240	100	4	75
260	100	4	75
280	100	4	75
300	100	4	75
350	100	4	75
400	100	4	75

Tabletop

HPL Fenix | see all finish options on page 184

Frame

Steel | see all finish options on page 185

Oak | see all finish options on page 183

# Dining Tables High | rectangular

Oak



Butterfly 92 or 105



Co 92 or 105



Legno (oak) 92 or 105



New Classic 92 or 105



New Co 92 or 105



Slim X-type 92 or 105



Length (cm)	Width (cm)	Thickness (cm)	Height (cm)
160	90	4	92/105
180	90	4	92/105
200	90	4	92/105
220	90	4	92/105
240	90	4	92/105
260	90	4	92/105
280	90	4	92/105
300	90	4	92/105
160	100	4	92/105
180	100	4	92/105
200	100	4	92/105
220	100	4	92/105
240	100	4	92/105
260	100	4	92/105
280	100	4	92/105
300	100	4	92/105

92 Height (cm)

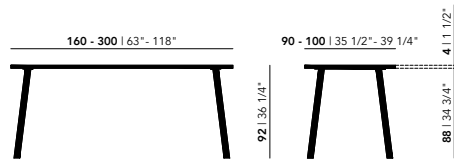
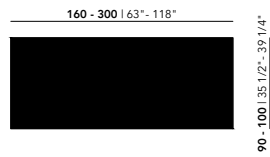

105 Height (cm)

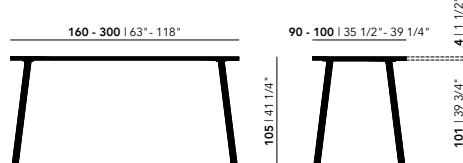
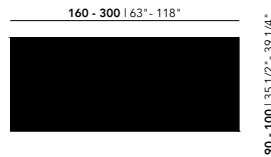

## Tabletop

Oak | see all finish options on page 183

## Frame

Steel | see all finish options on page 185

Oak | see all finish options on page 183



# Dining Tables High | rectangular

Walnut

standard

chamfered



Butterfly 92 or 105



Co 92 or 105



New Classic 92 or 105



New Co 92 or 105



Slim X-type 92 or 105



Length (cm)	Width (cm)	Thickness (cm)	Height (cm)
160	90	4	92/105
180	90	4	92/105
200	90	4	92/105
220	90	4	92/105
240	90	4	92/105
260	90	4	92/105
280	90	4	92/105
300	90	4	92/105
160	100	4	92/105
180	100	4	92/105
200	100	4	92/105
220	100	4	92/105
240	100	4	92/105
260	100	4	92/105
280	100	4	92/105
300	100	4	92/105

92 Height (cm)

105 Height (cm)

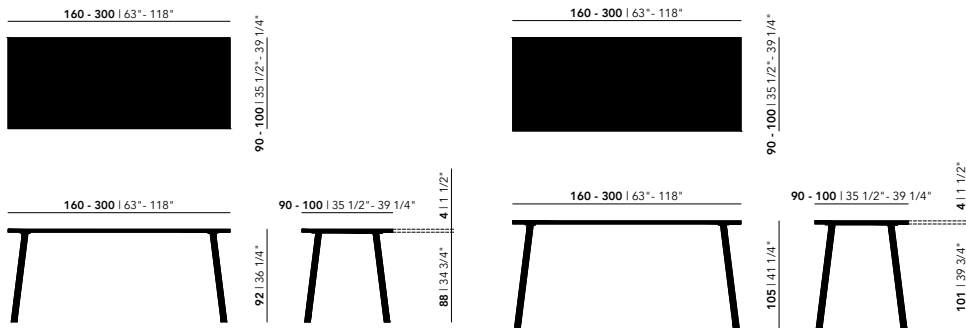

Tabletop

Walnut | see all finish options on page 183

Frame

Steel | see all finish options on page 185

# Dining Tables High | rectangular

HPL Fenix



Butterfly 92 or 105



Co 92 or 105



Legno (oak) 92 or 105



New Classic 92 or 105



New Co 92 or 105



Slim X-type 92 or 105



92 Height (cm)

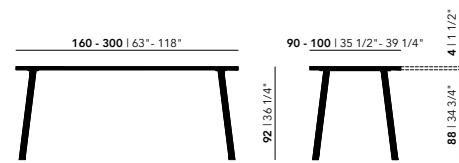
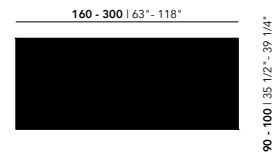

105 Height (cm)

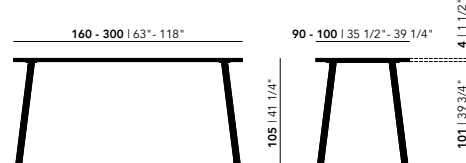
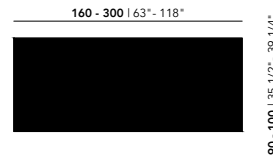

Length (cm)	Width (cm)	Thickness (cm)	Height (cm)
160	90	4	92/105
180	90	4	92/105
200	90	4	92/105
220	90	4	92/105
240	90	4	92/105
260	90	4	92/105
280	90	4	92/105
300	90	4	92/105
160	100	4	92/105
180	100	4	92/105
200	100	4	92/105
220	100	4	92/105
240	100	4	92/105
260	100	4	92/105
280	100	4	92/105
300	100	4	92/105

## Tabletop

HPL Fenix | see all finish options on page 184

## Frame

Steel | see all finish options on page 185

Oak | see all finish options on page 183

# Dining Tables | flat oval

Oak

standard



chamfered



Base (oak)



Butterfly

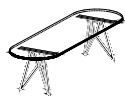

Co



Legno (oak)



New Classic



New Co



Slim Co



Slim X-type



Topple

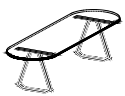

Cylinder (oak)



Flyta



200 - 400 | 78 3/4" - 157 1/2"



90 - 100 | 35 1/2" - 39 1/4"

200 - 400 | 78 3/4" - 157 1/2"



74 - 75 | 29 1/4" - 29 1/2"

90 - 100 | 35 1/2" - 39 1/4"

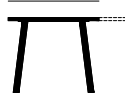

71 | 28" - 3 - 4 | 1 1/4" - 1 1/2"

Length (cm)	Width (cm)	Thickness (cm)	Height (cm)
200	90	3	74
220	90	3	74
240	90	3	74
260	90	3	74
280	90	3	74
300	90	3	74
200	100	3	74
220	100	3	74
240	100	3	74
260	100	3	74
280	100	3	74
300	100	3	74
200	90	4	75
220	90	4	75
240	90	4	75
260	90	4	75
280	90	4	75
300	90	4	75
350	90	4	75
400	90	4	75
200	100	4	75
220	100	4	75
240	100	4	75
260	100	4	75
280	100	4	75
300	100	4	75
350	100	4	75
400	100	4	75

Tabletop

Oak | see all finish options on page 183

Frame

Steel | see all finish options on page 185

Oak | see all finish options on page 183

# Dining Tables | flat oval

Walnut

standard



chamfered



Butterfly

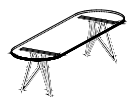

Co



New Classic



New Co



Slim Co



Slim X-type



Topple

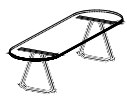

Flyta

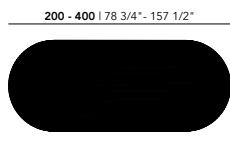

90 - 100 | 35 1/2\"/>

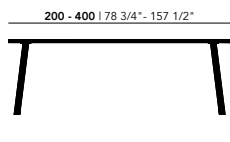

74 - 75 | 29 1/4\"/>

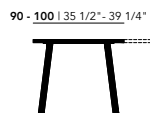

71 | 28\"/>

3 - 4 | 1 1/4\"/>

Length (cm)	Width (cm)	Thickness (cm)	Height (cm)
200	90	3	74
220	90	3	74
240	90	3	74
260	90	3	74
280	90	3	74
300	90	3	74
200	100	3	74
220	100	3	74
240	100	3	74
260	100	3	74
280	100	3	74
300	100	3	74
200	90	4	75
220	90	4	75
240	90	4	75
260	90	4	75
280	90	4	75
300	90	4	75
350	90	4	75
400	90	4	75
200	100	4	75
220	100	4	75
240	100	4	75
260	100	4	75
280	100	4	75
300	100	4	75
350	100	4	75
400	100	4	75

Tabletop

Walnut | see all finish options on page 183

Frame

Steel | see all finish options on page 185

# Dining Tables | flat oval

HPL Fenix

standard



chamfered



Base (oak)



Butterfly

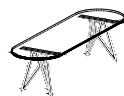

Co



Legno (oak)



New Classic



New Co



Slim Co



Slim X-type



Topple

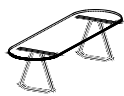

Cylinder (oak)



Flyta

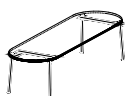

200 - 400 | 78 3/4" - 157 1/2"



90 | 100 | 35 1/2" - 39 1/4"

200 - 400 | 78 3/4" - 157 1/2"

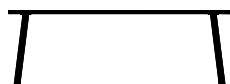

75 | 29 1/2"

90 - 100 | 35 1/2" - 39 1/4"



4 | 1 1/2"

71 | 28"

Length (cm)	Width (cm)	Thickness (cm)	Height (cm)
200	90	4	75
220	90	4	75
240	90	4	75
260	90	4	75
280	90	4	75
300	90	4	75
350	90	4	75
400	90	4	75
200	100	4	75
220	100	4	75
240	100	4	75
260	100	4	75
280	100	4	75
300	100	4	75
350	100	4	75
400	100	4	75

Tabletop

HPL Fenix | see all finish options on page 184

Frame

Steel | see all finish options on page 185

Oak | see all finish options on page 183

# Dining Tables High | flat oval

Oak



Butterfly 92 or 105



Co 92 or 105



Legno (oak) 92 or 105



New Classic 92 or 105



New Co 92 or 105



Slim X-type 92 or 105



Length (cm)	Width (cm)	Thickness (cm)	Height (cm)
200	90	4	92/105
220	90	4	92/105
240	90	4	92/105
260	90	4	92/105
280	90	4	92/105
300	90	4	92/105
200	100	4	92/105
220	100	4	92/105
240	100	4	92/105
260	100	4	92/105
280	100	4	92/105
300	100	4	92/105

92 Height (cm)

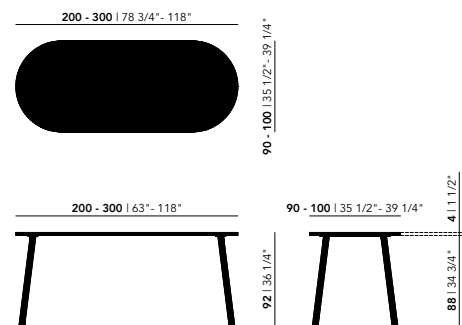

105 Height (cm)

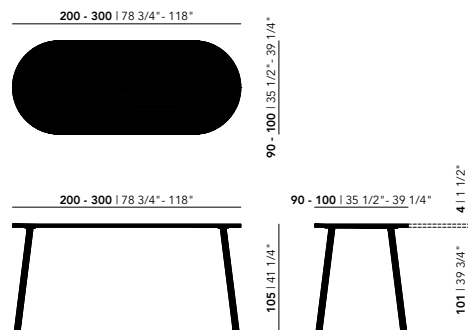

Tabletop

Oak | see all finish options on page 183

Frame

Steel | see all finish options on page 185

Oak | see all finish options on page 183

# Dining Tables High | flat oval

Walnut



Butterfly 92 or 105



Co 92 or 105



New Classic 92 or 105



New Co 92 or 105



Slim X-type 92 or 105



92 Height (cm)

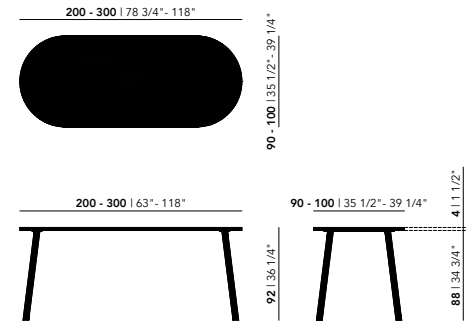

105 Height (cm)

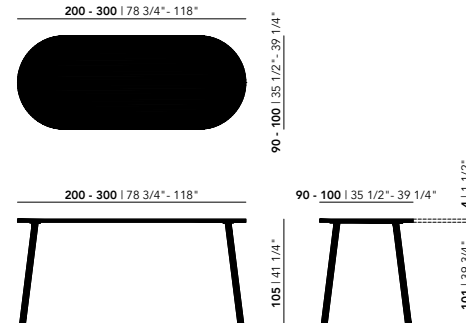

Length (cm)	Width (cm)	Thickness (cm)	Height (cm)
200	90	4	92/105
220	90	4	92/105
240	90	4	92/105
260	90	4	92/105
280	90	4	92/105
300	90	4	92/105
200	100	4	92/105
220	100	4	92/105
240	100	4	92/105
260	100	4	92/105
280	100	4	92/105
300	100	4	92/105

Tabletop

Walnut | see all finish options on page 183

Frame

Steel | see all finish options on page 185

# Dining Tables High | flat oval

HPL Fenix



Butterfly 92 or 105



Co 92 or 105



Legno (oak) 92 or 105



New Classic 92 or 105



New Co 92 or 105



Slim X-type 92 or 105



Length (cm)	Width (cm)	Thickness (cm)	Height (cm)
200	90	4	92/105
220	90	4	92/105
240	90	4	92/105
260	90	4	92/105
280	90	4	92/105
300	90	4	92/105
200	100	4	92/105
220	100	4	92/105
240	100	4	92/105
260	100	4	92/105
280	100	4	92/105
300	100	4	92/105

92 Height (cm)

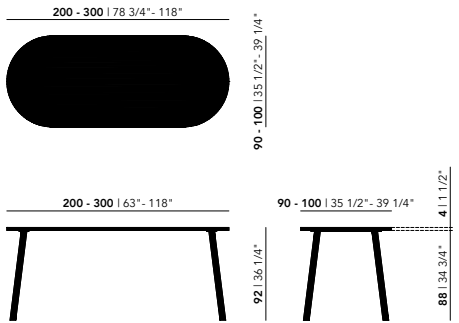

105 Height (cm)

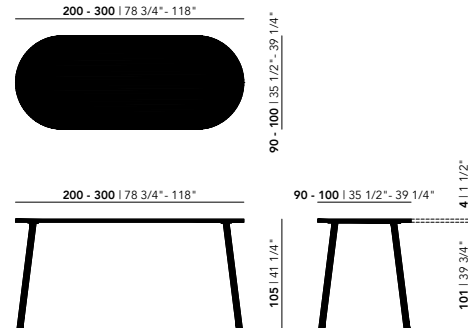

Tabletop

HPL Fenix | see all finish options on page 184

Frame

Steel | see all finish options on page 185

Oak | see all finish options on page 183



# Dining Tables | Slot

Flat oval | Oak & Walnut

chamfered



Flat Oval

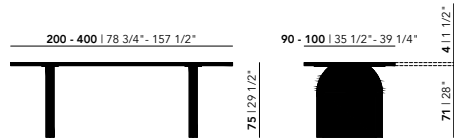
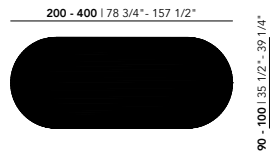
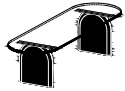

Length (cm)	Width (cm)	Thickness (cm)	Height (cm)
200	90	4	75
220	90	4	75
240	90	4	75
260	90	4	75
280	90	4	75
300	90	4	75
350	90	4	75
400	90	4	75
200	100	4	75
220	100	4	75
240	100	4	75
260	100	4	75
280	100	4	75
300	100	4	75
350	100	4	75
400	100	4	75

Tabletop

Oak | see all finish options on page 183

Walnut | see all finish options on page 183

Frame

Oak | see all finish options on page 183

Walnut | see all finish options on page 183

# Dining Tables | Slot

Blob | Oak & Walnut

chamfered



Blob



Length (cm)	Width (cm)	Thickness (cm)	Height (cm)
200	100	4	75
220	100	4	75
240	100	4	75
260	100	4	75
280	100	4	75
300	100	4	75
350	120	4	75
400	120	4	75

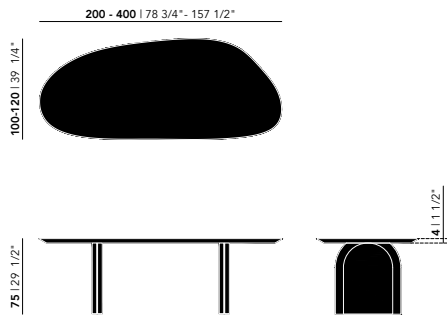

Tabletop

Oak | see all finish options on page 183

Walnut | see all finish options on page 183

Frame

Oak | see all finish options on page 183

Walnut | see all finish options on page 183

# Dining Tables | Slot

Round | Oak & Walnut

chamfered



Diameter 100-120 cm

Slot Tripod



Diameter 130-150 cm

Slot Quadpod



Diameter 160-180 cm

Slot Quadpod XL

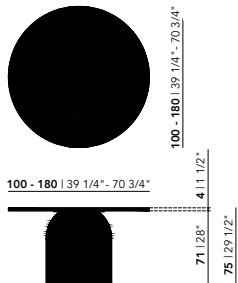

Tabletop

Oak | see all finish options on page 183

Walnut | see all finish options on page 183

Frame

Oak | see all finish options on page 183

Walnut | see all finish options on page 183

Diameter (cm)	Thickness (cm)	Height (cm)
100	4	75
110	4	75
120	4	75
130	4	75
140	4	75
150	4	75
160	4	75
170	4	75
180	4	75

# Dining Tables | oval

Oak

standard



chamfered



Butterfly

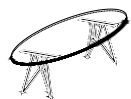

Co



Legno (oak)

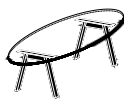

New Classic

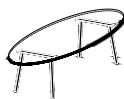

New Co

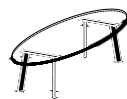

Slim Co

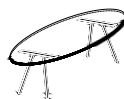

Slim X-type



Topple

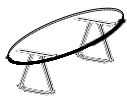

Cylinder (oak)



Length (cm)	Width (cm)	Thickness (cm)	Height (cm)
200	120	3	74
220	120	3	74
240	120	3	74
260	120	3	74
280	120	3	74
300	120	3	74
200	120	4	75
220	120	4	75
240	120	4	75
260	120	4	75
280	120	4	75
300	120	4	75
350	150	4	75
400	150	4	75

200 - 400 | 78 3/4" - 157 1/2"

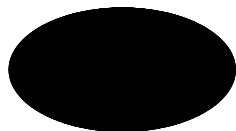

120 - 150 | 47 1/4" - 59"

200 - 400 | 78 3/4" - 157 1/2"

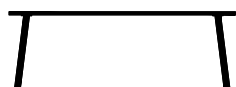

74 - 75 | 29 1/4" - 29 1/2"

120 - 150 | 47 1/4" - 59"



3 - 4 | 11 1/4" - 11 1/2"

71 | 28"

Tabletop

Oak | see all finish options on page 183

Frame

Steel | see all finish options on page 185

Oak | see all finish options on page 183

# Dining Tables | oval

Walnut

standard



chamfered



Butterfly

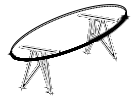

Co

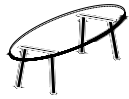

New Classic

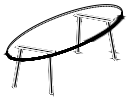

New Co

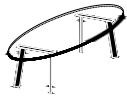

Slim Co

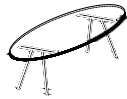

Slim X-type

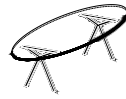

Topple

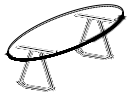

200 - 400 | 78 3/4" - 157 1/2"

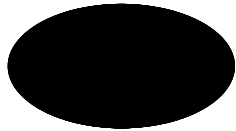

120 - 150 | 47 1/4" - 59"

200 - 400 | 78 3/4" - 157 1/2"



75 | 29 1/4" - 29 1/2"

120 - 150 | 47 1/4" - 59"

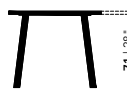

3 - 4 | 11 1/4" - 11 1/2"

71 | 28"

Length (cm)	Width (cm)	Thickness (cm)	Height (cm)
200	120	3	74
220	120	3	74
240	120	3	74
260	120	3	74
280	120	3	74
300	120	3	74
200	120	4	75
220	120	4	75
240	120	4	75
260	120	4	75
280	120	4	75
300	120	4	75
350	150	4	75
400	150	4	75

Tabletop

Walnut | see all finish options on page 183

Frame

Steel | see all finish options on page 185

# Dining Tables | oval

HPL Fenix

standard



chamfered



Butterfly

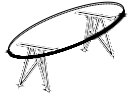

Co



Legno (oak)



New Classic

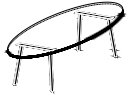

New Co



Slim Co

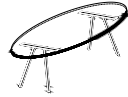

Slim X-type

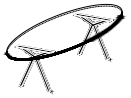

Topple

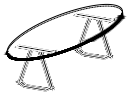

Cylinder (oak)



Length (cm)	Width (cm)	Thickness (cm)	Height (cm)
200	120	4	75
220	120	4	75
240	120	4	75
260	120	4	75
280	120	4	75
300	120	4	75
350	150	4	75
400	150	4	75

200 - 400 | 78 3/4" - 157 1/2"

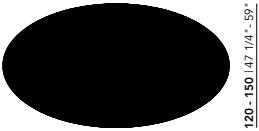

120 - 150 | 47 1/4" - 59"

200 - 400 | 78 3/4" - 157 1/2"



75 | 29 1/2"

120 - 150 | 47 1/4" - 59"



71 | 28"

Tabletop

HPL Fenix | see all finish options on page 184

Frame

Steel | see all finish options on page 185

Oak | see all finish options on page 183

# Dining Tables High | oval

Oak



Butterfly 92 or 105

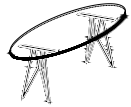

Co 92 or 105

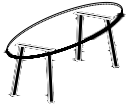

Legno (oak) 92 or 105



New Classic 92 or 105



New Co 92 or 105



Slim X-type 92 or 105



Length (cm)	Width (cm)	Thickness (cm)	Height (cm)
200	120	4	92/105
220	120	4	92/105
240	120	4	92/105
260	120	4	92/105
280	120	4	92/105
300	120	4	92/105

92 Height (cm)

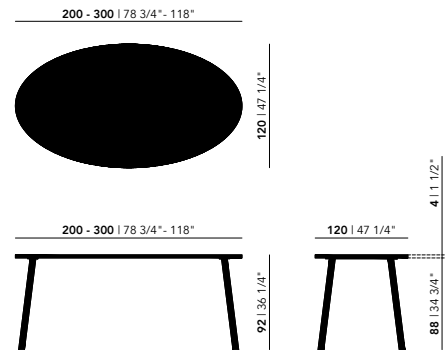

105 Height (cm)

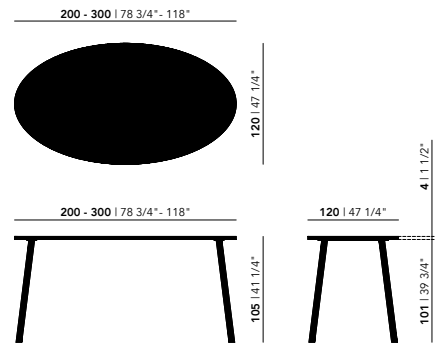

Tabletop

Oak | see all finish options on page 183

Frame

Steel | see all finish options on page 185

Oak | see all finish options on page 183

# Dining Tables High | oval

Walnut

standard

chamfered



Butterfly 92 or 105

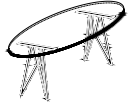

Co 92 or 105

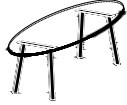

New Classic 92 or 105



New Co 92 or 105



Slim X-type 92 or 105



Length (cm)	Width (cm)	Thickness (cm)	Height (cm)
200	120	4	92/105
220	120	4	92/105
240	120	4	92/105
260	120	4	92/105
280	120	4	92/105
300	120	4	92/105

92 Height (cm)

105 Height (cm)

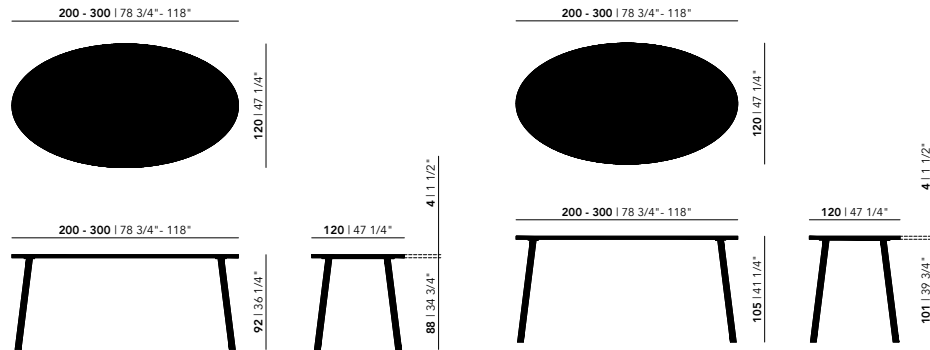

Tabletop

Walnut | see all finish options on page 183

Frame

Steel | see all finish options on page 185



# Dining Tables High | oval

HPL Fenix

standard

chamfered



Butterfly 92 or 105

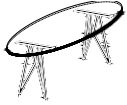

Co 92 or 105



Legno (oak) 92 or 105



New Classic 92 or 105



New Co 92 or 105



Slim X-type 92 or 105



Length (cm)	Width (cm)	Thickness (cm)	Height (cm)
200	120	4	92/105
220	120	4	92/105
240	120	4	92/105
260	120	4	92/105
280	120	4	92/105
300	120	4	92/105

92 Height (cm)

105 Height (cm)

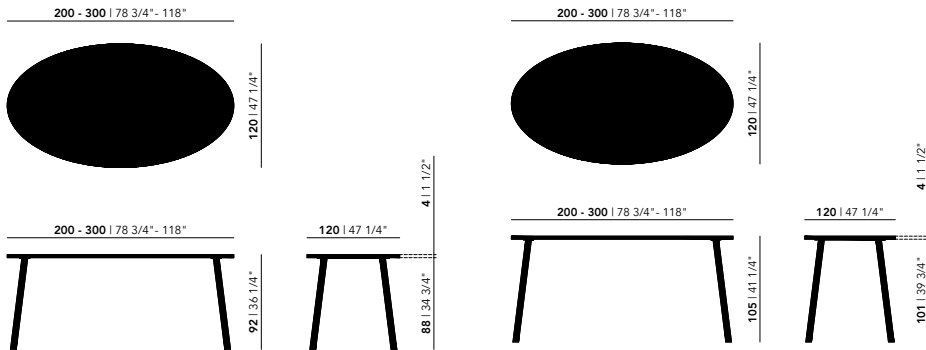

Tabletop

HPL Fenix | see all finish options on page 184

Frame

Steel | see all finish options on page 185

Oak | see all finish options on page 183

# Dining Tables | blob

Oak

standard



chamfered



Butterfly



New Classic



Slim Co



Slim X-Type



Cylinder (Oak)



Length (cm)	Width (cm)	Thickness (cm)	Height (cm)
200	100	3	74
220	100	3	74
240	100	3	74
260	100	3	74
280	100	3	74
300	100	3	74
200	100	4	75
220	100	4	75
240	100	4	75
260	100	4	75
280	100	4	75
300	100	4	75
350	120	4	75
400	120	4	75

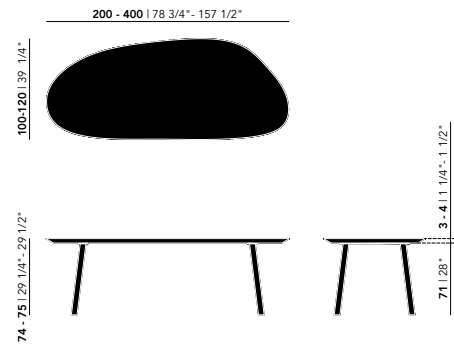

Tabletop

Oak | see all finish options on page 183

Frame

Steel | see all finish options on page 185

Oak | see all finish options on page 183

# Dining Tables | blob

Walnut

standard



chamfered



Butterfly



New Classic



Slim Co



Slim X-Type



Length (cm)	Width (cm)	Thickness (cm)	Height (cm)
200	100	3	74
220	100	3	74
240	100	3	74
260	100	3	74
280	100	3	74
300	100	3	74
200	100	4	75
220	100	4	75
240	100	4	75
260	100	4	75
280	100	4	75
300	100	4	75
350	120	4	75
400	120	4	75

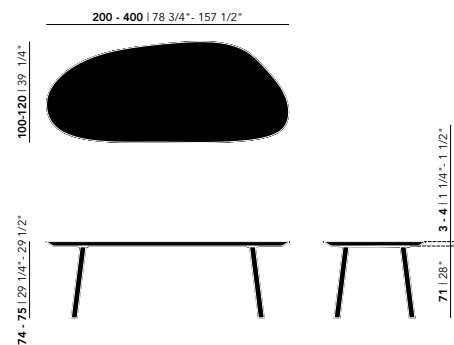

Tabletop

Walnut | see all finish options on page 183

Frame

Steel | see all finish options on page 185

# Dining Tables | blob

HPL Fenix

standard



chamfered



Butterfly



New Classic



Slim Co



Slim X-Type



Cylinder (Oak)



Length (cm)	Width (cm)	Thickness (cm)	Height (cm)
200	100	4	75
220	100	4	75
240	100	4	75
260	100	4	75
280	100	4	75
300	100	4	75
350	120	4	75
400	120	4	75

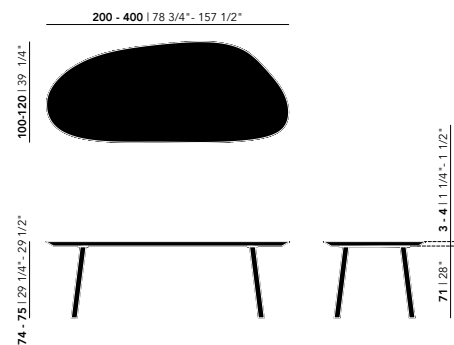

Tabletop

HPL Fenix | see all finish options on page 184

Frame

Steel | see all finish options on page 185

Oak | see all finish options on page 183

# Dining Tables | round

Oak



Diameter 100-120 cm

Butterfly Tripod

Curve Quadpod M

New Classic Tripod

New Co Tripod



Diameter 130-150 cm

Butterfly Quadpod

Curve Quadpod L

New Classic Quadpod

New Co Quadpod

Flyta Quadpod

Column Quadpod



Diameter 160-180 cm

Butterfly Quadpod XL

Curve Quadpod XL

New Classic Quadpod XL

New Co Quadpod XL

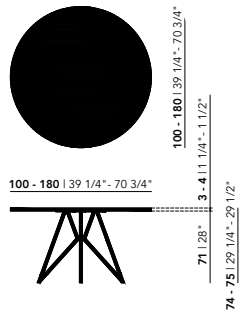
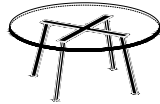

Tabletop

Oak | see all finish options on page 183

Frame

Steel | see all finish options on page 183

Diameter (cm)	Thickness (cm)	Height (cm)
100	3	74
110	3	74
120	3	74
130	3	74
140	3	74
150	3	74
160	3	74
170	3	74
180	3	74
100	4	75
110	4	75
120	4	75
130	4	75
140	4	75
150	4	75
160	4	75
170	4	75
180	4	75

# Dining Tables | round

Walnut



Diameter 100-120 cm

Butterfly Tripod

Curve Quadpod M

New Classic Tripod

New Co Tripod



Diameter 130-150 cm

Butterfly Quadpod

Curve Quadpod L

New Classic Quadpod

New Co Quadpod

Flyta Quadpod

Column Quadpod



Diameter 160-180 cm

Butterfly Quadpod XL

Curve Quadpod XL

New Classic Quadpod XL

New Co Quadpod XL

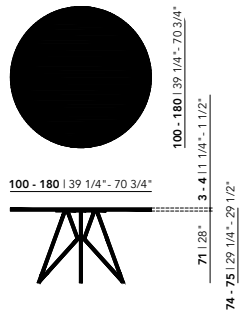
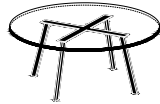

Diameter (cm)	Thickness (cm)	Height (cm)
100	3	74
110	3	74
120	3	74
130	3	74
140	3	74
150	3	74
160	3	74
170	3	74
180	3	74
100	4	75
110	4	75
120	4	75
130	4	75
140	4	75
150	4	75
160	4	75
170	4	75
180	4	75

Tabletop

Walnut | see all finish options on page 183

Frame

Steel | see all finish options on page 185

# Dining Tables | round

HPL Fenix



## Diameter 100-120 cm

Butterfly Tripod

Curve Quadpod M

New Classic Tripod

New Co Tripod



## Diameter 130-150 cm

Butterfly Quadpod

Curve Quadpod L

New Classic Quadpod

New Co Quadpod

Flyta Quadpod



## Diameter 160-180 cm

Butterfly Quadpod XL

Curve Quadpod XL

New Classic Quadpod XL

New Co Quadpod XL

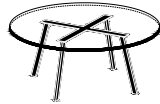

Diameter (cm)	Thickness (cm)	Height (cm)
100	4	75
110	4	75
120	4	75
130	4	75
140	4	75
150	4	75
160	4	75

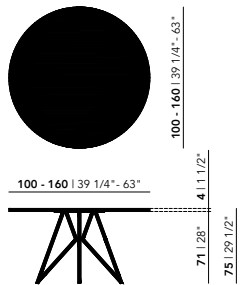

Tabletop

HPL Fenix | see all finish options on page 184

Frame

Steel | see all finish options on page 185

# Amoeba Collection



Amoeba Coffee Table

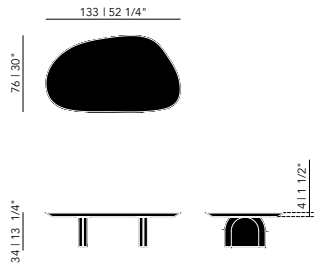

Amoeba Coffee Table

Length (cm)	Width (cm)	Thickness (cm)	Height (cm)
133	76	4	34

Amoeba Dining Table

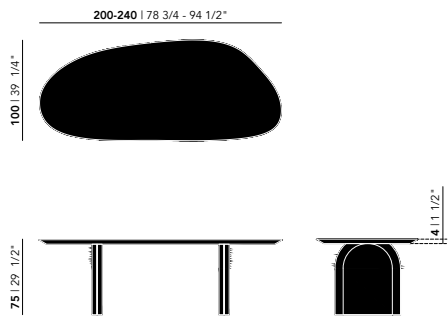

Amoeba Dining Table

Length (cm)	Width (cm)	Thickness (cm)	Height (cm)
200	100	4	75
220	100	4	75
240	100	4	75

## Tabletop

0004, 0005 | see all finish options on page 183

## Frame

0004, 0005 | see all finish options on page 183



# Home Desks

Oak



Butterfly

New Classic

Slim X-type

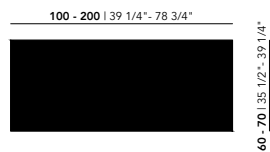

60 - 70 | 35 1/2\"/>

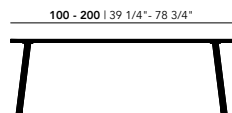

74 - 75 | 29 1/4\"/>

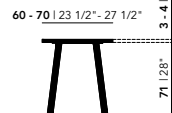

3 - 4 | 11 1/4\"/>

Tabletop

Oak | see all finish options on page 183

Frame

Steel | see all finish options on page 185

Oak | see all finish options on page 183

Length (cm)	Width (cm)	Thickness (cm)	Height (cm)
100	60	3	74
120	60	3	74
140	60	3	74
160	60	3	74
180	60	3	74
200	60	3	74
100	70	3	74
120	70	3	74
140	70	3	74
160	70	3	74
180	70	3	74
200	70	3	74
100	60	4	75
120	60	4	75
140	60	4	75
160	60	4	75
180	60	4	75
200	60	4	75
100	70	4	75
120	70	4	75
140	70	4	75
160	70	4	75
180	70	4	75
200	70	4	75

# Home Desks

Walnut

standard



chamfered



Butterfly



New Classic



Slim X-type

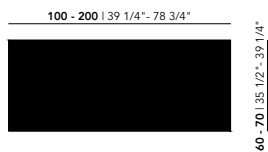
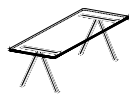

60 - 70 | 35 1/2\"/>

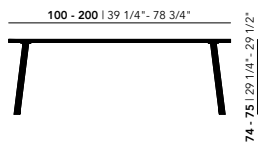

74 - 75 | 29 1/4\"/>

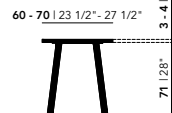

3 - 4 | 11 1/4\"/>

71 | 28\"/>

Length (cm)	Width (cm)	Thickness (cm)	Height (cm)
100	60	3	74
120	60	3	74
140	60	3	74
160	60	3	74
180	60	3	74
200	60	3	74
100	70	3	74
120	70	3	74
140	70	3	74
160	70	3	74
180	70	3	74
200	70	3	74
100	60	4	75
120	60	4	75
140	60	4	75
160	60	4	75
180	60	4	75
200	60	4	75
100	70	4	75
120	70	4	75
140	70	4	75
160	70	4	75
180	70	4	75
200	70	4	75

Tabletop

Walnut | see all finish options on page 183

Frame

Steel | see all finish options on page 185

# Home Desks

HPL Fenix

standard



chamfered



Butterfly



New Classic



Slim X-type



Length (cm)	Width (cm)	Thickness (cm)	Height (cm)
100	60	4	75
120	60	4	75
140	60	4	75
160	60	4	75
180	60	4	75
200	60	4	75
100	70	4	75
120	70	4	75
140	70	4	75
160	70	4	75
180	70	4	75
200	70	4	75

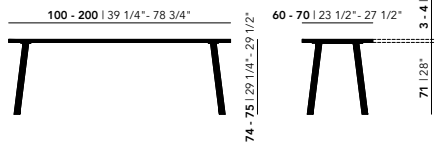
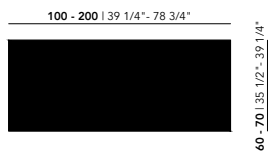

Tabletop

HPL Fenix | see all finish options on page 184

Frame

Steel | see all finish options on page 185

# Bistro Tables

Oak



Central



Rest

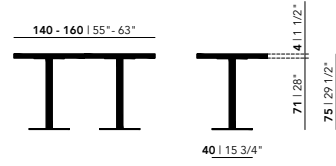
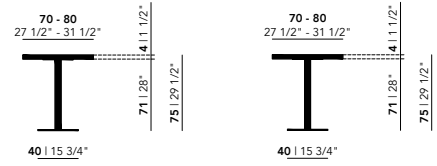
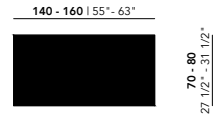
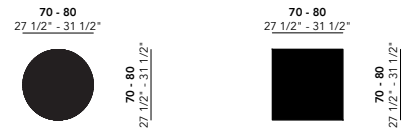

Round

Diameter (cm)	Thickness (cm)	Height (cm)
70	4	75
80	4	75

Square

Length (cm)	Width (cm)	Thickness (cm)	Height (cm)
70	70	4	75
80	80	4	75

Rectangular

Length (cm)	Width (cm)	Thickness (cm)	Height (cm)
140	70	4	75
160	80	4	75

Tabletop

Oak | see all finish options on page 183

Frame

Steel | see all finish options on page 185

# Bistro Tables

HPL Fenix

standard

chamfered



Central



Rest



70 - 80  
27 1/2" - 31 1/2"



70 - 80  
27 1/2" - 31 1/2"

70 - 80  
27 1/2" - 31 1/2"



70 - 80  
27 1/2" - 31 1/2"

140 - 160 | 55° - 63°



70 - 80  
27 1/2" - 31 1/2"

70 - 80  
27 1/2" - 31 1/2"



40 | 15 3/4"

4 | 1 1/2"

71 | 28"

75 | 29 1/2"

70 - 80  
27 1/2" - 31 1/2"



40 | 15 3/4"

4 | 1 1/2"

71 | 28"

75 | 29 1/2"

140 - 160 | 55° - 63°



40 | 15 3/4"

4 | 1 1/2"

71 | 28"

75 | 29 1/2"

Round

Diameter (cm)	Thickness (cm)	Height (cm)
70	4	75
80	4	75

Square

Length (cm)	Width (cm)	Thickness (cm)	Height (cm)
70	70	4	75
80	80	4	75

Rectangular

Length (cm)	Width (cm)	Thickness (cm)	Height (cm)
140	70	4	75
160	80	4	75

Tabletop

HPL Fenix | see all finish options on page 184

Frame

Steel | see all finish options on page 185

# Bistro Tables High

Oak



Central 92 or 105 (cm)

Rest 92 or 105 (cm)



70 - 80  
27 1/2" - 31 1/2"



70 - 80  
27 1/2" - 31 1/2"

70 - 80  
27 1/2" - 31 1/2"



70 - 80  
27 1/2" - 31 1/2"

140 - 160 | 55° - 63°



70 - 80  
27 1/2" - 31 1/2"

92 Height (cm)

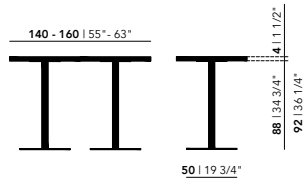
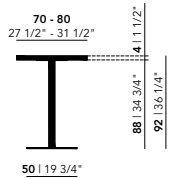
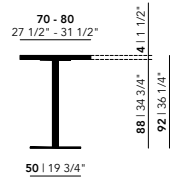

105 Height (cm)

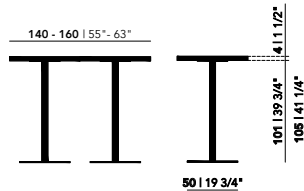
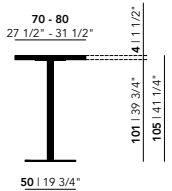
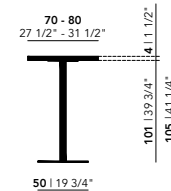

Tabletop

Oak | see all finish options on page 183

Frame

Steel | see all finish options on page 185

Round

Diameter (cm)	Thickness (cm)	Height (cm)
70	4	92/105
80	4	92/105

Square

Length (cm)	Width (cm)	Thickness (cm)	Height (cm)
70	70	4	92/105
80	80	4	92/105

Rectangular

Length (cm)	Width (cm)	Thickness (cm)	Height (cm)
140	70	4	92/105
160	80	4	92/105

# Bistro Tables High

HPL Fenix



Central 92 or 105 (cm)



Rest 92 or 105 (cm)



70 - 80  
27 1/2" - 31 1/2"



70 - 80  
27 1/2" - 31 1/2"

70 - 80  
27 1/2" - 31 1/2"



70 - 80  
27 1/2" - 31 1/2"

140 - 160 | 55° - 63°



70 - 80  
27 1/2" - 31 1/2"

92 Height (cm)

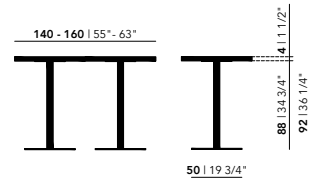
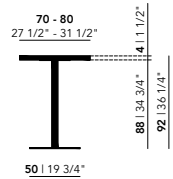
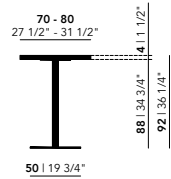

105 Height (cm)

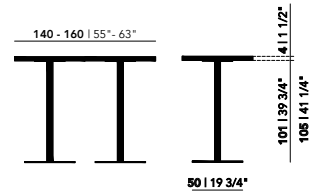
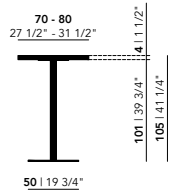
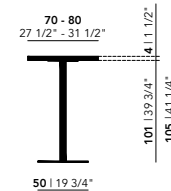

Tabletop

HPL Fenix | see all finish options on page 184

Frame

Steel | see all finish options on page 185

Round

Diameter (cm)	Thickness (cm)	Height (cm)
70	4	75
80	4	75

Square

Length (cm)	Width (cm)	Thickness (cm)	Height (cm)
70	70	4	75
80	80	4	75

Rectangular

Length (cm)	Width (cm)	Thickness (cm)	Height (cm)
140	70	4	75
160	80	4	75

# Dining Benches | rectangular

Oak

standard

chamfered



Base Bench (oak)

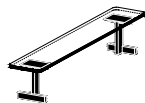

Butterfly Bench



Legno Bench (oak)



New Classic Bench



Slim X-type Bench



140 - 260 | 55" - 102 1/4"



40 | 15 3/4"

140 - 260 | 55" - 102 1/4"

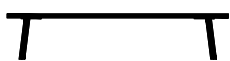

45 | 17 3/4"

41 | 16 1/4"

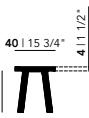

Length (cm)	Width (cm)	Thickness (cm)	Height (cm)
140	40	4	45
160	40	4	45
180	40	4	45
200	40	4	45
220	40	4	45
240	40	4	45
260	40	4	45

Seat

Oak | see all finish options on page 183

Frame

Steel | see all finish options on page 185

Oak | see all finish options on page 183



# Dining Benches | rectangular

Walnut

standard



chamfered



Butterfly Bench



New Classic Bench



Slim X-type Bench

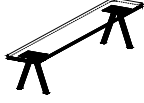

140 - 260 | 55" - 102 1/4"



40 | 15 3/4"

140 - 260 | 55" - 102 1/4"

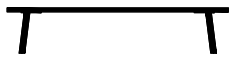

45 | 17 3/4"

41 | 16 1/4"

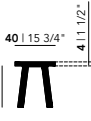

40 | 15 3/4"

41 | 17 1/2"

Length (cm)	Width (cm)	Thickness (cm)	Height (cm)
140	40	4	45
160	40	4	45
180	40	4	45
200	40	4	45
220	40	4	45
240	40	4	45
260	40	4	45

Seat

Walnut | see all finish options on page 183

Frame

Steel | see all finish options on page 185

# Dining Benches | rectangular

HPL Fenix

standard

chamfered



Base Bench (oak)

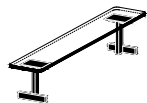

Butterfly Bench



Legno Bench (oak)



New Classic Bench



Slim X-type Bench

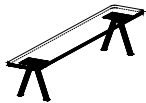

140 - 260 | 55" - 102 1/4"



40 | 15 3/4"

140 - 260 | 55" - 102 1/4"

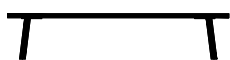

45 | 17 3/4"

41 | 16 1/4"

40 | 15 3/4"

41 | 16 1/4"

Length (cm)	Width (cm)	Thickness (cm)	Height (cm)
140	40	4	45
160	40	4	45
180	40	4	45
200	40	4	45
220	40	4	45
240	40	4	45
260	40	4	45

Seat

HPL Fenix | see all finish options on page 184

Frame

Steel | see all finish options on page 185

Oak | see all finish options on page 183

# Dining Benches | flat oval

Oak



Base Bench (oak)



Butterfly Bench

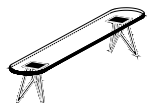

Legno Bench (oak)



New Classic Bench



Slim X-type Bench



140 - 260 | 55" - 102 1/4"



40 | 15 3/4"

140 - 260 | 55" - 102 1/4"

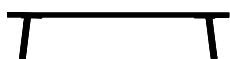

45 | 17 3/4"

41 | 16 1/4"

40 | 15 3/4"

4 | 1 1/2"

Length (cm)	Width (cm)	Thickness (cm)	Height (cm)
140	40	4	45
160	40	4	45
180	40	4	45
200	40	4	45
220	40	4	45
240	40	4	45
260	40	4	45

Seat

Oak | see all finish options on page 183

Frame

Steel | see all finish options on page 185

Oak | see all finish options on page 183

# Dining Benches | flat oval

Walnut

standard



chamfered



Butterfly Bench

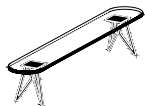

New Classic Bench

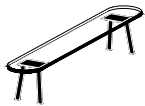

Slim X-type Bench



140 - 260 | 55" - 102 1/4"



40 | 15 3/4"

140 - 260 | 55" - 102 1/4"

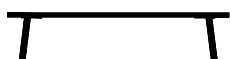

45 | 17 3/4"

41 | 16 1/4"

40 | 15 3/4"

4 | 1 1/2"

Length (cm)	Width (cm)	Thickness (cm)	Height (cm)
140	40	4	45
160	40	4	45
180	40	4	45
200	40	4	45
220	40	4	45
240	40	4	45
260	40	4	45

Seat

Walnut | see all finish options on page 183

Frame

Steel | see all finish options on page 185

# Dining Benches | flat oval

HPL Fenix

standard

chamfered



Base Bench (oak)



Butterfly Bench

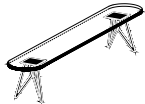

Legno Bench (oak)



New Classic Bench



Slim X-type Bench



140 - 260 | 55" - 102 1/4"



40 | 15 3/4"

140 - 260 | 55" - 102 1/4"

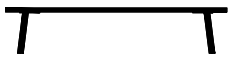

45 | 17 3/4"

41 | 16 1/4"

40 | 15 3/4"

41 | 1 1/2"

Length (cm)	Width (cm)	Thickness (cm)	Height (cm)
140	40	4	45
160	40	4	45
180	40	4	45
200	40	4	45
220	40	4	45
240	40	4	45
260	40	4	45

Seat

HPL Fenix | see all finish options on page 184

Frame

Steel | see all finish options on page 185

Oak | see all finish options on page 183

# Dining Benches | Slot

Oak & Walnut

chamfered



Slot

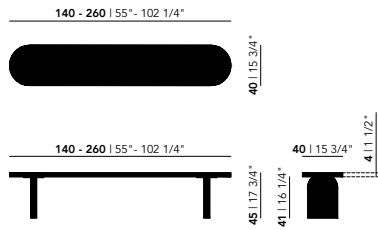
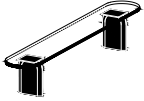

Length (cm)	Width (cm)	Thickness (cm)	Height (cm)
140	40	4	45
160	40	4	45
180	40	4	45
200	40	4	45
220	40	4	45
240	40	4	45
260	40	4	45

Seat

Oak | see all finish options on page 183

Walnut | see all finish options on page 183

Frame

Oak | see all finish options on page 183

Walnut | see all finish options on page 183

# Dining Bench | Coode

Coode Dining Bench 120

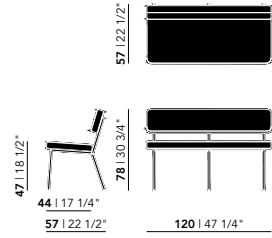

Coode Dining Bench 160

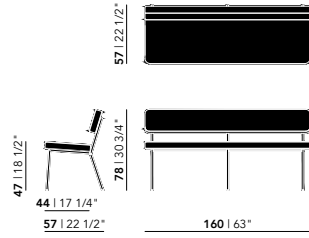

Coode Dining Bench 180

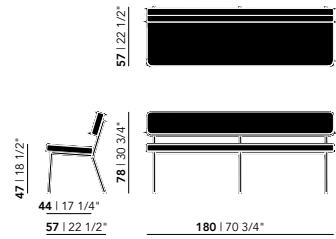

Coode Dining Bench 200

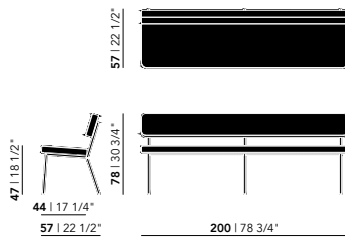

Coode Dining Bench 220

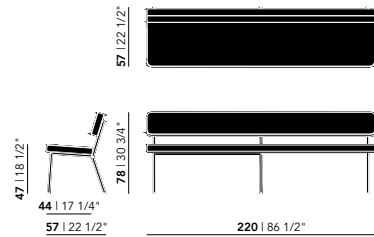

## Seating

Upholstery | see all fabric options on page 182

## Frame

Steel | see all finish options on page 185

## Coode Dining Bench 120

Upholstery Group A

Upholstery Group B

Upholstery Group C

Upholstery Group D

## Coode Dining Bench 160

Upholstery Group A

Upholstery Group B

Upholstery Group C

Upholstery Group D

## Coode Dining Bench 180

Upholstery Group A

Upholstery Group B

Upholstery Group C

Upholstery Group D

## Coode Dining Bench 200

Upholstery Group A

Upholstery Group B

Upholstery Group C

Upholstery Group D

## Coode Dining Bench 220

Upholstery Group A

Upholstery Group B

Upholstery Group C

Upholstery Group D

# Dining Bench Cushions

Dining Bench Cushion | Straight Corners

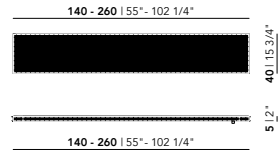

Dining Bench Cushion | Round Corners

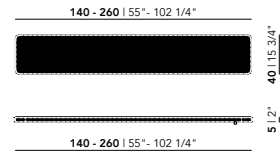

Dining Bench Cushion | Flat Oval

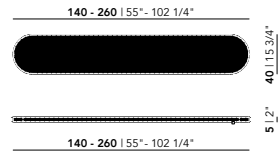

Upholstery Group A

Length (cm)	Width (cm)	Thickness (cm)
140	40	5
160	40	5
180	40	5
200	40	5
220	40	5
240	40	5
260	40	5

Upholstery Group B

Length (cm)	Width (cm)	Thickness (cm)
140	40	5
160	40	5
180	40	5
200	40	5
220	40	5
240	40	5
260	40	5

Upholstery Group C

Length (cm)	Width (cm)	Thickness (cm)
140	40	5
160	40	5
180	40	5
200	40	5
220	40	5
240	40	5
260	40	5

Upholstery Group D

Length (cm)	Width (cm)	Thickness (cm)
140	40	5
160	40	5
180	40	5
200	40	5
220	40	5
240	40	5
260	40	5

Upholstery  
See all fabric options on page 182



# Coffee Tables

Oak

chamfered



Butterfly Quadpod Coffee Table | round

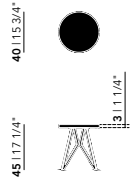

New Co Coffee Table 40 | round

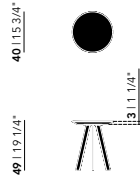

New Co Coffee Table 50 | round

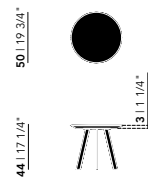

New Co Coffee Table 70 | round

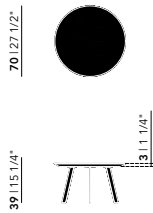

New Co Coffee Table 90 | round

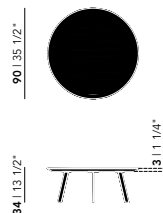

New Co Coffee Table 50 | square

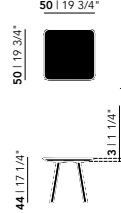

New Co Coffee Table 70 | square

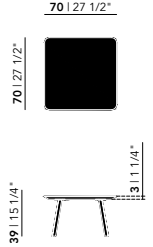

New Co Coffee Table 90 | square

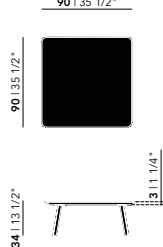

New Co Coffee Table 120 | rectangular

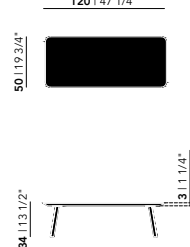

Butterfly Quadpod Coffee Table | round

Diameter (cm)	Thickness (cm)	Height (cm)
40	3	45

New Co Coffee Table | round

Diameter (cm)	Thickness (cm)	Height (cm)
40	3	49
50	3	44
70	3	39
90	3	34

New Co Coffee Table | square

Length (cm)	Width (cm)	Thickness (cm)	Height (cm)
50	50	3	44
70	70	3	39
90	90	3	34

New Co Coffee Table | rectangular

Length (cm)	Width (cm)	Thickness (cm)	Height (cm)
120	50	3	34

Tabletop

Oak | see all finish options on page 183

Frame

Steel | see all finish options on page 185

# Coffee Tables

HPL Fenix

chamfered



Butterfly Quadpod Coffee Table | round

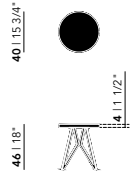

New Co Coffee Table 40 | round

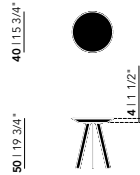

New Co Coffee Table 50 | round

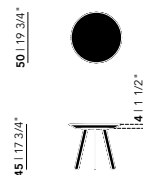

New Co Coffee Table 70 | round

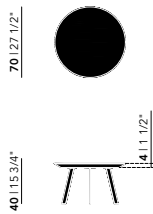

New Co Coffee Table 90 | round

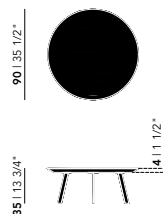

New Co Coffee Table 50 | square

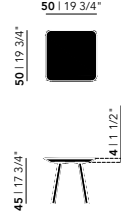

New Co Coffee Table 70 | square

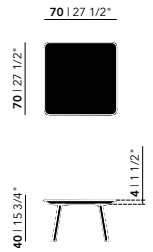

New Co Coffee Table 90 | square

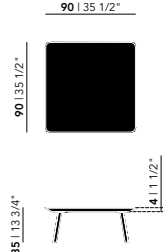

New Co Coffee Table 120 | rectangular

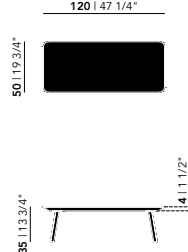

Tabletop

HPL Fenix | see all finish options on page 184

Frame

Steel | see all finish options on page 185

Butterfly Quadpod Coffee Table | round

Diameter (cm)	Thickness (cm)	Height (cm)
40	4	46

New Co Coffee Table | round

Diameter (cm)	Thickness (cm)	Height (cm)
40	4	50
50	4	45
70	4	40
90	4	35

New Co Coffee Table | square

Length (cm)	Width (cm)	Thickness (cm)	Height (cm)
50	50	4	45
70	70	4	40
90	90	4	35

New Co Coffee Table | rectangular

Length (cm)	Width (cm)	Thickness (cm)	Height (cm)
120	50	4	35

# Coffee Tables | Slot

Oak & Walnut

chamfered



Slot Coffee Table

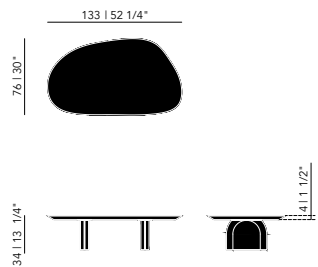

Slot Coffee Table

Length (cm)	Width (cm)	Thickness (cm)	Height (cm)
133	76	4	34

## Table top

Oak | see all finish options on page 183

Walnut | see all finish options on page 183

## Frame

Oak | see all finish options on page 183

Walnut | see all finish options on page 183

# Coffee Tables | Elements

Oak



Elements Coffee Table | 120

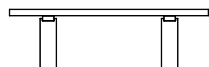
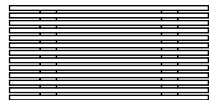

Code: ELEMCT120  
 Total length: 120 cm  
 Total width: 57 cm  
 Total height: 33,5 cm

Elements Coffee Table | 170

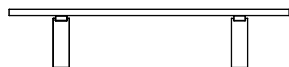
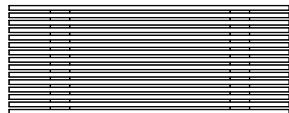

Code: ELEMCT170  
 Total length: 170 cm  
 Total width: 66 cm  
 Total height: 33,5 cm

Elements Coffee Table | 120

Length (cm)	Width (cm)	Thickness (cm)	Height (cm)
120	57	4	35,5

Elements Coffee Table | 170

Length (cm)	Width (cm)	Thickness (cm)	Height (cm)
170	66	4	35,5

## Tabletop

Oak | see all finish options on page 183

## Frame

Oak | see all finish options on page 183

# Coffee Tables | Scissors

Oak veneer

Scissors Coffee Table 50

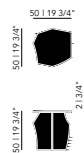

Scissors Coffee Table 70

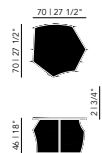

Scissors Coffee Table 90

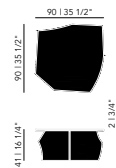

Scissors Coffee Table

Length (cm)	Width (cm)	Thickness (cm)	Height (cm)
50	50	2	50
70	50	2	46
90	90	2	40

## Tabletop

Lacquered oak veneer | RAL1013, RAL9005, RAL 7032, RAL 8017, RAL 8024

## Frame

Lacquered oak veneer | RAL1013, RAL9005, RAL 7032, RAL 8017, RAL 8024

# Dining Chairs

## Co Chair

### Co Chair Without Armrests

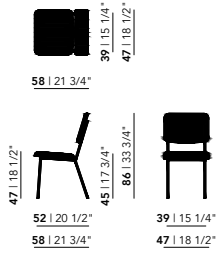

### Co Chair With Armrests

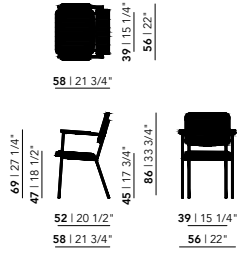

## Co Chair Without Armrests

Upholstery Group A

---

Upholstery Group B

---

Upholstery Group C

---

Upholstery Group D

---

## Co Chair With Armrests

Upholstery Group A

---

Upholstery Group B

---

Upholstery Group C

---

Upholstery Group D

---

## Seating

Upholstery | see all fabric options on page 182

## Armrests

Oak | see all finish options on page 183

## Frame

Steel | see all finish options on page 185

# Dining Chairs

## Ode Chair

### Ode Chair Without Armrests

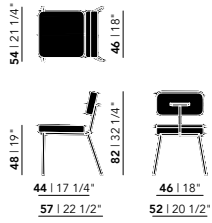

### Ode Chair With Armrests

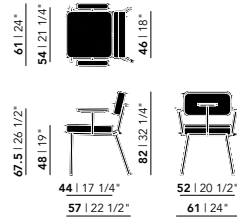

### Ode Chair Without Armrests

Upholstery Group A

---

Upholstery Group B

---

Upholstery Group C

---

Upholstery Group D

---

### Ode Chair With Armrests

Upholstery Group A

---

Upholstery Group B

---

Upholstery Group C

---

Upholstery Group D

---

## Seating

Upholstery | see all fabric options on page 182

## Armrests

Oak | see all finish options on page 183

## Frame

Steel | see all finish options on page 185

# Dining Chairs

## Base Chair

### Base Chair With Armrests

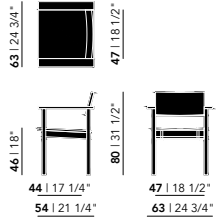

### Base Chair Without Armrests

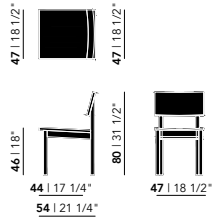

Base Chair With Armrests

---

---

Base Chair With Armrests | Upholstered Seat  
Upholstery Group A

---

---

Upholstery Group B

---

---

Upholstery Group C

---

---

Upholstery Group D

---

---

Base Chair Without Armrests

---

---

## Frame

Oak | finish options: 0003, 9017 | see finish options on page 183

## Seating

Upholstery | see all fabric options on page 182



# Dining Chairs

## Oblique Chair

Oblique Chair (wooden backrest)

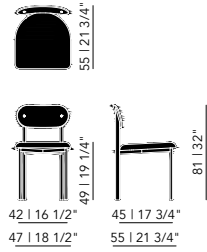

Oblique Chair Upholstered (upholstered backrest)

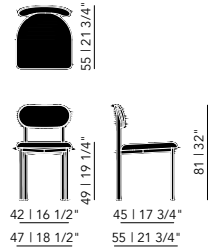

Oblique Chair (wooden backrest)

Upholstery Group A  
\_\_\_\_\_

Upholstery Group B  
\_\_\_\_\_

Upholstery Group C  
\_\_\_\_\_

Upholstery Group D  
\_\_\_\_\_

Oblique Chair Upholstered (upholstered backrest)

Upholstery Group A  
\_\_\_\_\_

Upholstery Group B  
\_\_\_\_\_

Upholstery Group C  
\_\_\_\_\_

Upholstery Group D  
\_\_\_\_\_

### Seat & backrest

Upholstery | see all fabric options on page 182

### Wooden Backrest

Plywood with oak veneer | see all finish options on page 183 (walnut finish excluded)

### Frame

Steel | see all finish options on page 185

# Stools

## Ode Bar Stool

### Ode Bar Stool 65

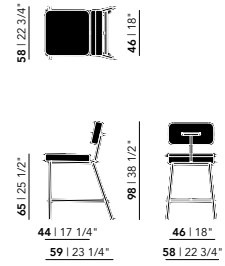

### Ode Bar Stool 77

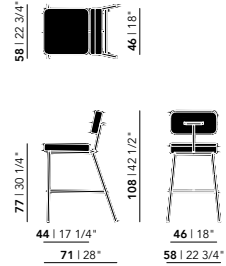

Upholstery Group A

Upholstery Group B

Upholstery Group C

Upholstery Group D

## Seating

Upholstery | see all fabric options on page 182

## Frame

Steel | see all finish options on page 185

# Stools

## Base Stool

Base stool 45

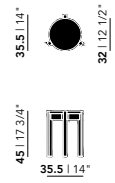

Base stool 65

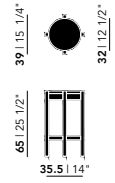

Base stool 77

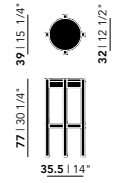

Base Stool 45

---

Base Stool 65

---

Base Stool 77

---

Frame

Oak | see all finish options on page 183

# Stools

## Bolster

Bolster Stool 65

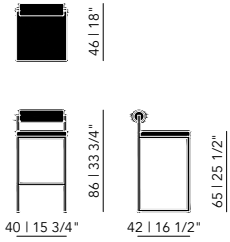

Bolster Stool 77

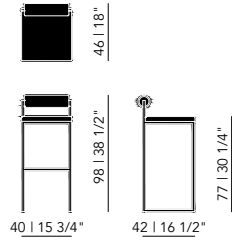

Upholstery Group A

---

Upholstery Group B

---

Upholstery Group C

---

Upholstery Group D

---

## Seating

Upholstery | see all fabric options on page 182

## Frame

Steel | see all finish options on page 185

# Cabinets

## Modular Cabinet

### Modular Cabinet

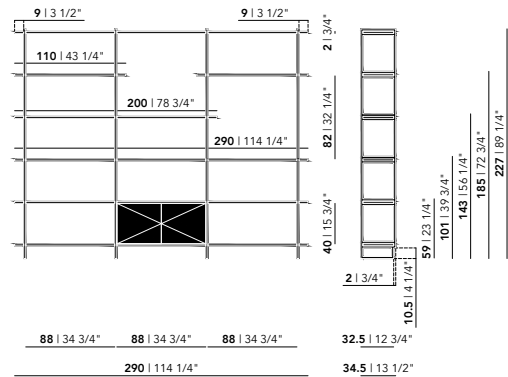

### Oak Element

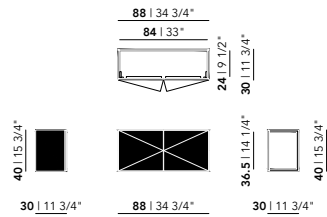

### Shelves

Oak | see all finish options on page 183

### Oak element

Oak | see all finish options on page 183

### Frame

Steel | see all finish options on page 185

Model	Height (cm)	Width (cm)
MC-2L	59	110
MC-2L	59	200
MC-2L	59	290
MC-3L	101	110
MC-3L	101	200
MC-3L	101	290
MC-4L	143	110
MC-4L	143	200
MC-4L	143	290
MC-5L	185	110
MC-5L	185	200
MC-5L	185	290
MC-6L	227	110
MC-6L	227	200
MC-6L	227	290

### Oak element\*

The cabinet is delivered with shelves of the chosen width. The choice of shelves shorter than the normal width of the cabinet does not affect the price. Recessed frame for plinth 10,5x2 cm.

\* Order separately

# Cabinets

## Modular Cabinet Stand Alone

### Modular Cabinet Stand Alone

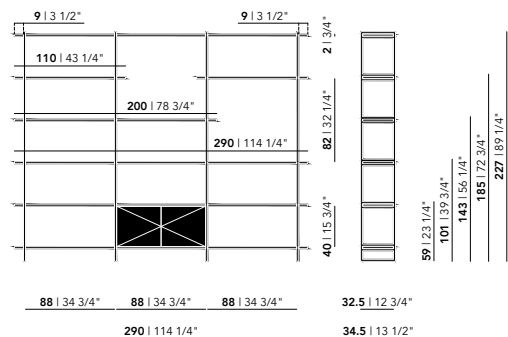

### Oak Element

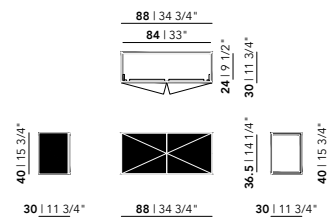

### Shelves

Oak | see all finish options on page 183

### Oak element

Oak | see all finish options on page 183

### Frame

Steel | see all finish options on page 185

Model	Height (cm)	Width (cm)
MC-2LSA	59	110
MC-2LSA	59	200
MC-2LSA	59	290
MC-3LSA	101	110
MC-3LSA	101	200
MC-3LSA	101	290
MC-4LSA	143	110
MC-4LSA	143	200
MC-4LSA	143	290
MC-5LSA	185	110
MC-5LSA	185	200
MC-5LSA	185	290
MC-6LSA	227	110
MC-6LSA	227	200
MC-6LSA	227	290

Oak element\*

The cabinet is delivered with shelves of the chosen width. The choice of shelves shorter than the normal width of the cabinet does not affect the price. Cross braces are included.

\* Order separately

# Cabinets

## Oblique Cabinet

Oblique Cabinet | 155

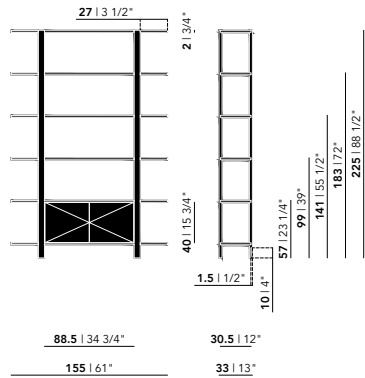

Oblique Cabinet | 250

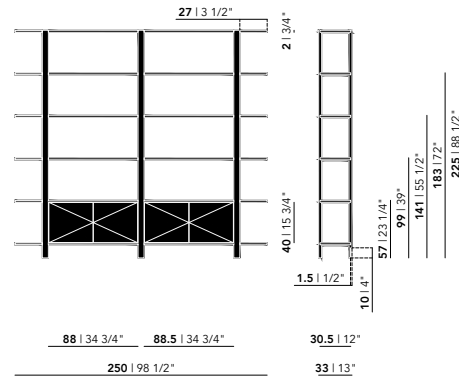

## Oak Element

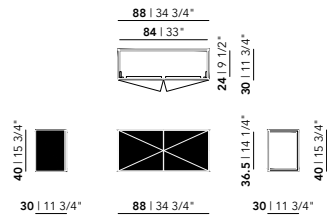

## Shelves

Oak | see all finish options on page 183

## Oak element

Oak | see all finish options on page 183

## Frame

Steel | see all finish options on page 185

Model	Height (cm)	Width (cm)
OB-2L	57	155
OB-2L	57	250
OB-3L	99	155
OB-3L	99	250
OB-4L	141	155
OB-4L	141	250
OB-5L	183	155
OB-5L	183	250
OB-6L	225	155
OB-6L	225	250

Oak element\*

Recessed frame for plinth 10x1,5 cm.

\* Order seperately

# Dressers

## The Dresser

Model	Length (cm)	Depth (cm)	Height (cm)
The Dresser 21	166	45	59
The Dresser 22	166	45	90
The Dresser 31	246	45	59
The Dresser 32	246	45	90

The Dresser | 21

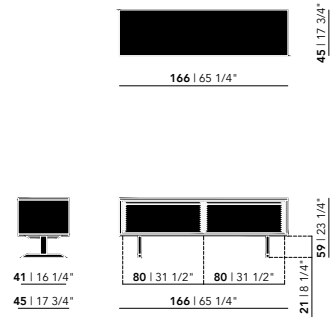

The Dresser | 22

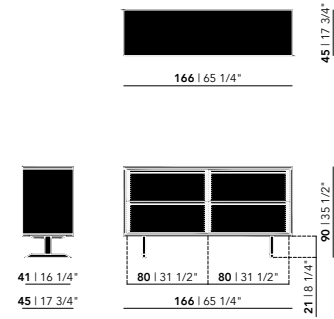

The Dresser | 31

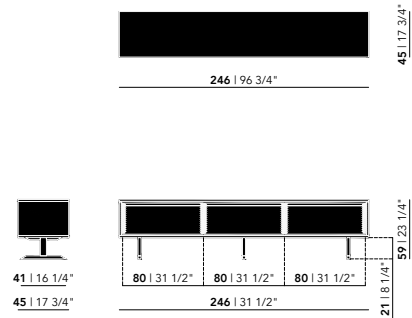

The Dresser | 32

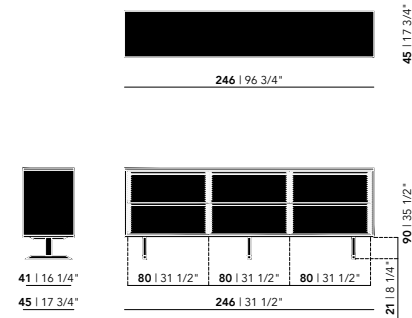

### Dresser

Oak | see all finish options on page 183

### Frame

Steel | see all finish options on page 185



# Sofas & Lounge Chairs

## Co Lounge

Co Lounge Chair | 1 seater

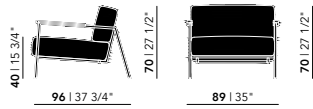
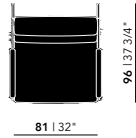

Co Lounge Sofa | 2.5 seater

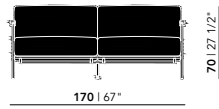
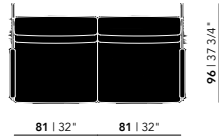

Co Lounge Sofa | 3.5 seater

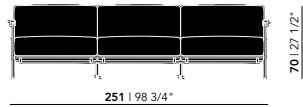
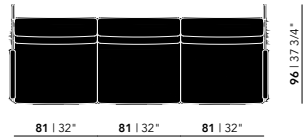

Co Lounge Ottoman

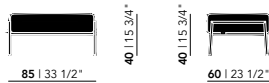
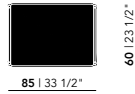

### Upholstery Group A

1 seater

2.5 seater

3.5 seater

Ottoman

### Upholstery Group B

1 seater

2.5 seater

3.5 seater

Ottoman

### Upholstery Group C

1 seater

2.5 seater

3.5 seater

Ottoman

### Upholstery Group D

1 seater

2.5 seater

3.5 seater

Ottoman

### Seating

Upholstery | see all fabric options on page 182

### Armrests

Oak | see all finish options on page 183

### Frame

Steel | see all finish options on page 185

# Sofas & Lounge Chairs

## Ode Lounge Without Armrests

Ode Lounge Chair Without Armrests | 1 seater

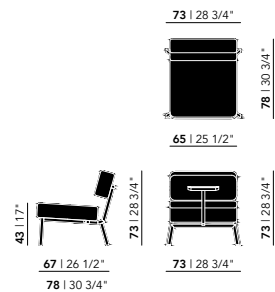

Ode Lounge Sofa Without Armrests | 2.5 seater

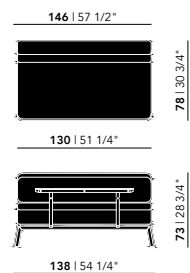

Ode Lounge Sofa Without Armrests | 3.5 seater

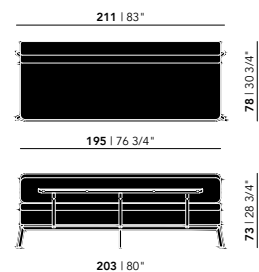

Ode Lounge Ottoman

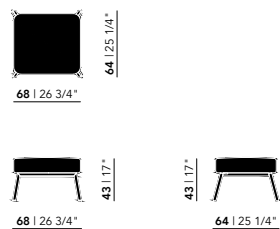

### Seating

Upholstery | see all fabric options on page 182

### Frame

Steel | see all finish options on page 185

### Upholstery Group A

1 seater

2.5 seater

3.5 seater

Ottoman

### Upholstery Group B

1 seater

2.5 seater

3.5 seater

Ottoman

### Upholstery Group C

1 seater

2.5 seater

3.5 seater

Ottoman

### Upholstery Group D

1 seater

2.5 seater

3.5 seater

Ottoman

# Sofas & Lounge Chairs

## Ode Lounge With Armrests

Ode Lounge Chair With Armrests | 1 seater

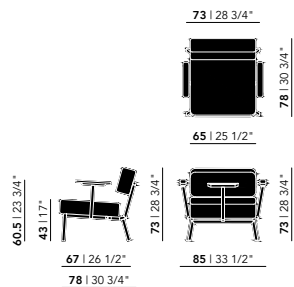

Ode Lounge Sofa With Armrests | 2.5 seater

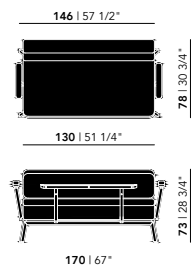

Ode Lounge Sofa With Armrests | 3.5 seater

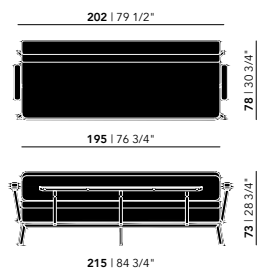

Ode Lounge Ottoman

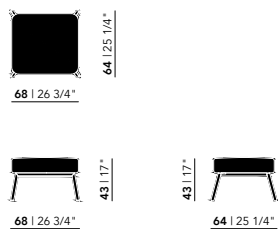

### Seating

Upholstery | see all fabric options on page 182

### Armrests

Oak | see all finish options on page 183

### Frame

Steel | see all finish options on page 185

### Upholstery Group A

1 seater

2.5 seater

3.5 seater

Ottoman

### Upholstery Group B

1 seater

2.5 seater

3.5 seater

Ottoman

### Upholstery Group C

1 seater

2.5 seater

3.5 seater

Ottoman

### Upholstery Group D

1 seater

2.5 seater

3.5 seater

Ottoman

# Sofas & Lounge Chairs

Luna Lounge

Luna Lounge

105 | 31 1/2"



70 | 27 1/2"

70 | 27 1/2"

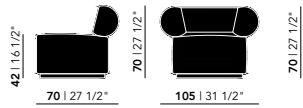

Upholstery Group A

---

Upholstery Group B

---

Upholstery Group C

---

Upholstery Group D

---

Seating

Upholstery | see all fabric options on page 182

Frame

Wood | black or white lacquer

# Sofas & Lounge Chairs

## Base Lounge

### Base Lounge

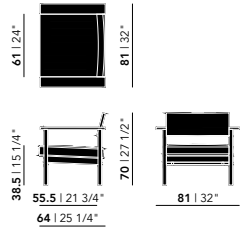

Upholstery Group A

---

Upholstery Group B

---

Upholstery Group C

---

Upholstery Group D

---

### Seating

Upholstery | see all fabric options on page 182

### Frame

Oak | see all finish options on page 183

# Sofas & Lounge Chairs

## Oblique Lounge

### Oblique Lounge

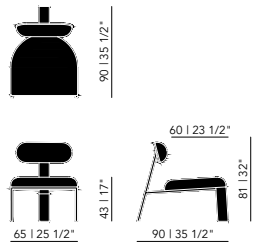

Upholstery Group A

---

Upholstery Group B

---

Upholstery Group C

---

Upholstery Group D

---

### Seating

Upholstery | see all fabric options on page 182

### Frame

Steel | see all finish options on page 185

# Sofas & Lounge Chairs

Lean Lounge

Lean Lounge

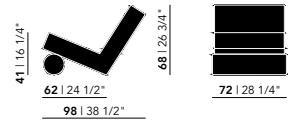
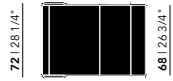

Upholstery Group A

---

Upholstery Group B

---

Upholstery Group C

---

Upholstery Group D

---

Seating

Upholstery | see all fabric options on page 182

# Sofas & Lounge Chairs

## Modulo

Modulo Lounge Chair | 1 seater

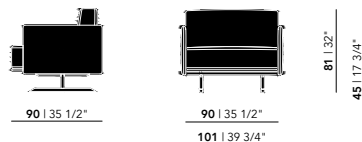

Modulo Sofa | 2 seater

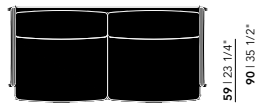

Modulo Sofa | 2.5 seater

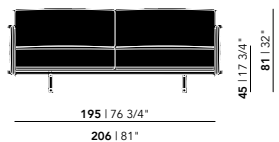
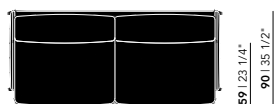

Modulo Sofa | 3 seater

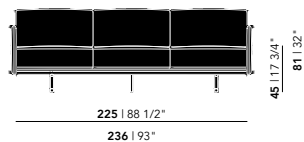
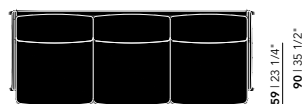

Modulo Sofa | 3.5 seater

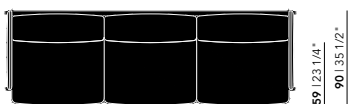

Modulo Lounge Chair | 1 seater

Upholstery Group A

Upholstery Group B

Upholstery Group C

Upholstery Group D

Modulo Sofa | 2 seater

Upholstery Group A

Upholstery Group B

Upholstery Group C

Upholstery Group D

Modulo Sofa | 2.5 seater

Upholstery Group A

Upholstery Group B

Upholstery Group C

Upholstery Group D

Modulo Sofa | 3 seater

Upholstery Group A

Upholstery Group B

Upholstery Group C

Upholstery Group D

Modulo Sofa | 3.5 seater

Upholstery Group A

Upholstery Group B

Upholstery Group C

Upholstery Group D

Seating

Upholstery | see all fabric options on page 182

Frame

Steel | see all finish options on page 185



# Sofas & Lounge Chairs

## Modulo

Modulo Sofa | 1.5 seater Arm Left/Right

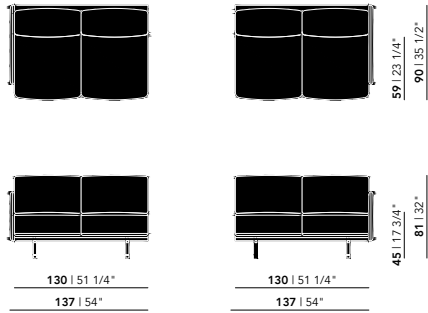

Modulo Sofa | 2 seater Arm Left/Right

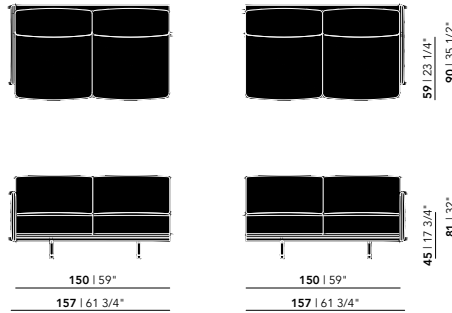

Modulo Sofa | 2.5 seater Arm Left/Right

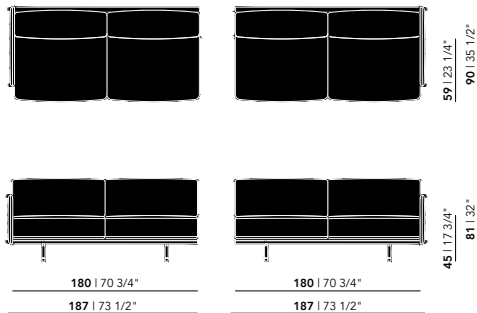

Modulo Sofa | 3 seater Arm Left/Right

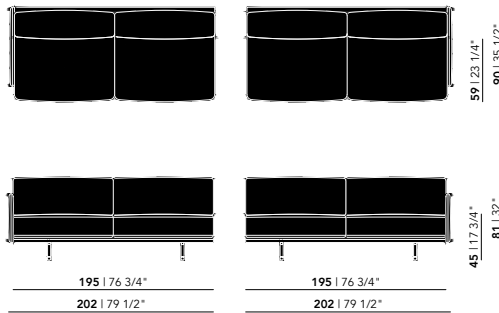

Modulo Sofa | 3.5 seater Arm Left/Right

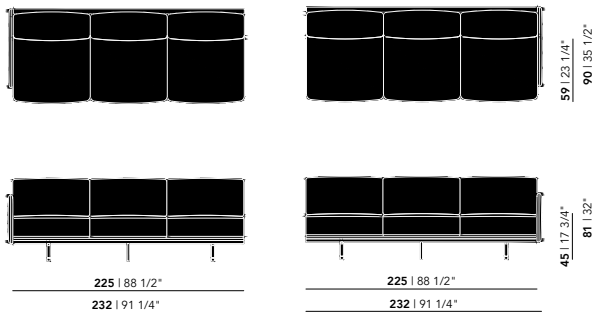

Modulo Sofa | 1.5 seater Arm Left/Right

- Upholstery Group A
- Upholstery Group B
- Upholstery Group C
- Upholstery Group D

Modulo Sofa | 2 seater Arm Left/Right

- Upholstery Group A
- Upholstery Group B
- Upholstery Group C
- Upholstery Group D

Modulo Sofa | 2.5 seater Arm Left/Right

- Upholstery Group A
- Upholstery Group B
- Upholstery Group C
- Upholstery Group D

Modulo Sofa | 3 seater Arm Left/Right

- Upholstery Group A
- Upholstery Group B
- Upholstery Group C
- Upholstery Group D

Modulo Sofa | 3.5 seater Arm Left/Right

- Upholstery Group A
- Upholstery Group B
- Upholstery Group C
- Upholstery Group D

Seating

Upholstery | see all fabric options on page 182

Frame

Steel | see all finish options on page 185

# Sofas & Lounge Chairs

## Modulo

Modulo | Hocker M

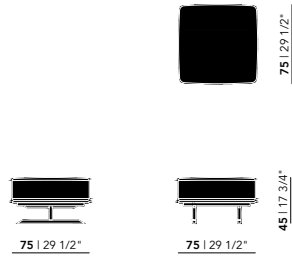

Modulo | Hocker L

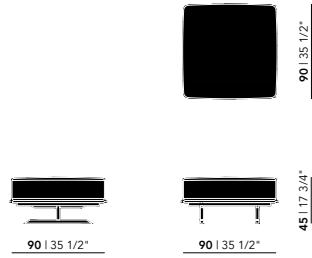

Modulo Sofa | Corner Element

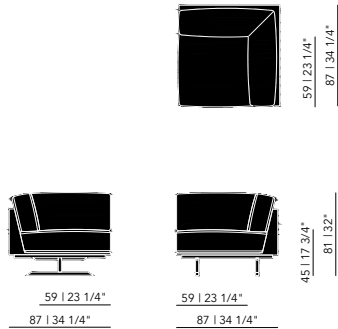

Modulo Sofa | Chaise Longue Arm Left/Right

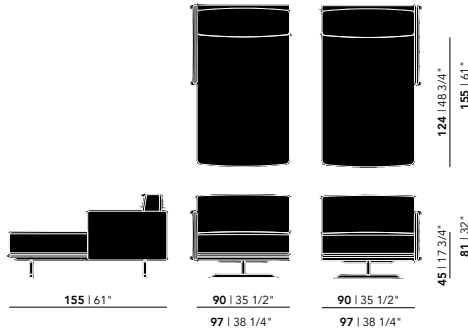

Modulo Sofa | Corner Element Platform Left/Right

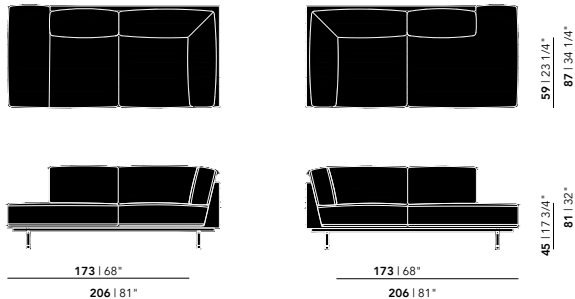

Modulo | Hocker M

Upholstery Group A

Upholstery Group B

Upholstery Group C

Upholstery Group D

Modulo | Hocker L

Upholstery Group A

Upholstery Group B

Upholstery Group C

Upholstery Group D

Modulo Sofa | Corner Element

Upholstery Group A

Upholstery Group B

Upholstery Group C

Upholstery Group D

Modulo Sofa | Chaise Longue Arm Left/Right

Upholstery Group A

Upholstery Group B

Upholstery Group C

Upholstery Group D

Modulo Sofa | Corner Element Platform Left/Right

Upholstery Group A

Upholstery Group B

Upholstery Group C

Upholstery Group D

Seating

Upholstery | see all fabric options on page 182

Frame

Steel | see all finish options on page 185

# Sofas & Lounge Chairs

## Cube

Cube Lounge Chair | 1 seater

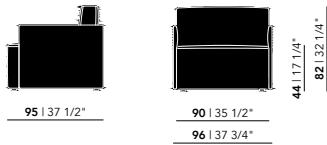

Cube Sofa | 2 seater

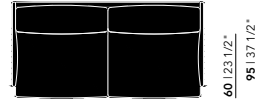

Cube Sofa | 2.5 seater

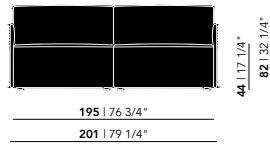
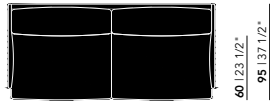

Cube Sofa | 3 seater

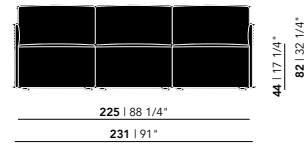
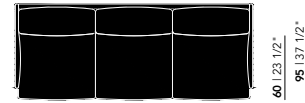

Cube Sofa | 3.5 seater

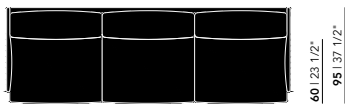

Cube Lounge Chair | 1 seater

Upholstery Group A

Upholstery Group B

Upholstery Group C

Upholstery Group D

Cube Sofa | 2 seater

Upholstery Group A

Upholstery Group B

Upholstery Group C

Upholstery Group D

Cube Sofa | 2.5 seater

Upholstery Group A

Upholstery Group B

Upholstery Group C

Upholstery Group D

Cube Sofa | 3 seater

Upholstery Group A

Upholstery Group B

Upholstery Group C

Upholstery Group D

Cube Sofa | 3.5 seater

Upholstery Group A

Upholstery Group B

Upholstery Group C

Upholstery Group D

Seating

Upholstery | see all fabric options on page 182

# Sofas & Lounge Chairs

## Cube

Cube Sofa | 1.5 seater Arm Left/Right

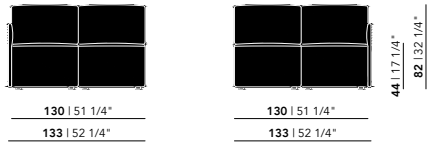
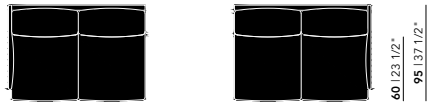

Cube Sofa | 2 seater Arm Left/Right

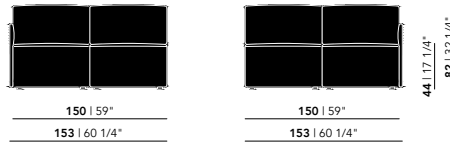

Cube Sofa | 2.5 seater Arm Left/Right

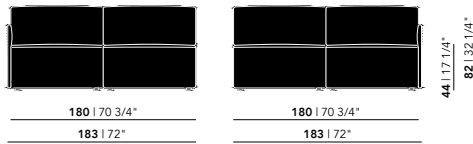
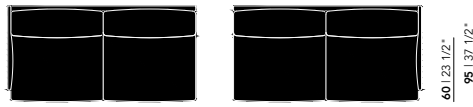

Cube Sofa | 3 seater Arm Left/Right

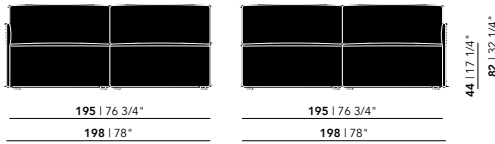
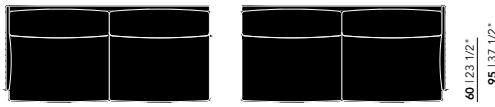

Cube Sofa | 3.5 seater Arm Left/Right

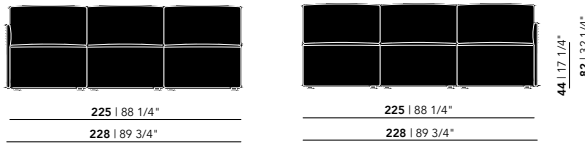
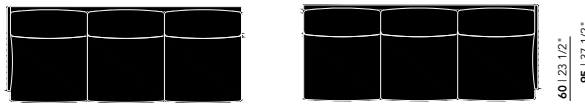

Cube Sofa | 1.5 seater Arm Left/Right

Upholstery Group A

Upholstery Group B

Upholstery Group C

Upholstery Group D

Cube Sofa | 2 seater Arm Left/Right

Upholstery Group A

Upholstery Group B

Upholstery Group C

Upholstery Group D

Cube Sofa | 2.5 seater Arm Left/Right

Upholstery Group A

Upholstery Group B

Upholstery Group C

Upholstery Group D

Cube Sofa | 3 seater Arm Left/Right

Upholstery Group A

Upholstery Group B

Upholstery Group C

Upholstery Group D

Cube Sofa | 3.5 seater Arm Left/Right

Upholstery Group A

Upholstery Group B

Upholstery Group C

Upholstery Group D

Seating

Upholstery | see all fabric options on page 182

# Sofas & Lounge Chairs

## Cube

Cube | Hocker M



75 | 29 1/2"



75 | 29 1/2"



75 | 29 1/2"

44 | 17 1/4"

Cube | Hocker L



90 | 35 1/2"



90 | 35 1/2"



90 | 35 1/2"

44 | 17 1/4"

Cube Sofa | Corner Element

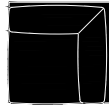

60 | 23 1/2"  
98 | 38 1/2"



60 | 23 1/2"  
98 | 38 1/2"



60 | 23 1/2"  
98 | 38 1/2"

44 | 17 1/4"  
82 | 32 1/4"

Cube Sofa | Chaise Longue Arm Left/Right

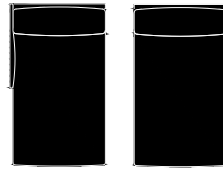

123 | 48 1/2"  
158 | 62 1/4"



158 | 62 1/4"



90 | 35 1/2"  
93 | 36 1/2"

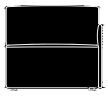

90 | 35 1/2"  
93 | 36 1/2"

44 | 17 1/4"  
82 | 32 1/4"

Cube Sofa | Corner Element Platform Left/Right

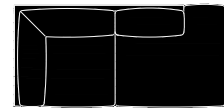
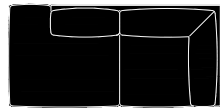

59 | 23 1/4"  
98 | 38 1/2"

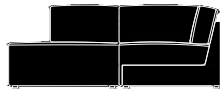

173 | 68"

206 | 81"

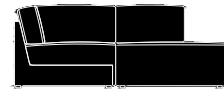

173 | 68"

206 | 81"



45 | 17 3/4"  
81 | 32"



59 | 23 1/4"

98 | 38 1/2"

Cube | Hocker M

Upholstery Group A

Upholstery Group B

Upholstery Group C

Upholstery Group D

Cube | Hocker L

Upholstery Group A

Upholstery Group B

Upholstery Group C

Upholstery Group D

Cube Sofa | Corner Element

Upholstery Group A

Upholstery Group B

Upholstery Group C

Upholstery Group D

Cube Sofa | Chaise Longue Arm Left/Right

Upholstery Group A

Upholstery Group B

Upholstery Group C

Upholstery Group D

Cube Sofa | Corner Element Platform Left/Right

Upholstery Group A

Upholstery Group B

Upholstery Group C

Upholstery Group D

## Seating

Upholstery | see all fabric options on page 182

## Sofas & Lounge Chairs

Cave

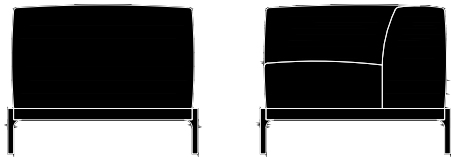
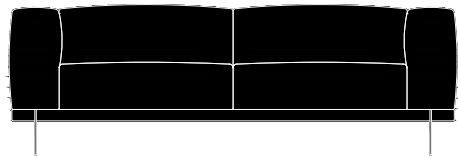
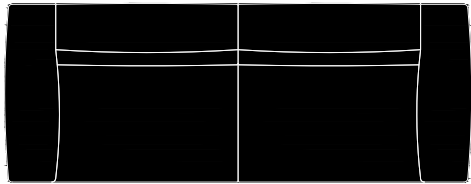

The Cave is a contemporary yet timeless sofa that is both visually appealing and comfortable. The idea behind the design was to create a roomy sofa that appears light, so it looks beautiful in smaller living spaces as well. The result is a comfortable design with a very elegant frame. Made with everyday life in mind, the Cave is the perfect sofa for evenings with the family and lazy Sunday afternoons. The modular system allows for endless variations.

Total depth: 94 cm

Total height: 78 cm

Seat depth: 63 cm

Seat height: 47 cm

Arm width: 25 cm

Arm height: 78 cm

Material construction: fiber board / pine framework / hardwood

Seat suspension: nosag

Material back: cold foam T18 foam a mix of feathers and memory foam fibers covered with a layer of 150 g / m<sup>2</sup> dacron

Material seat: cold foam HR3032 with a mix of feathers and memory foam fibers covered with a layer of 150 g / m<sup>2</sup> dacron

Material legs: metal

Frame finish: black (9005) or white (9016)

Upholstery | see all fabric options on page 182

# Sofas & Lounge Chairs

Cave

Cave Lounge Chair | 1 seater

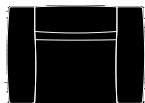

Code: cav15  
Total width: 130 cm  
Total depth: 94 cm

Cave Sofa | 2,5 seater

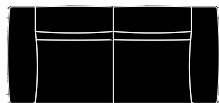

Code: cav35  
Total width: 211 cm  
Total depth: 94 cm

Cave Sofa | 3 seater



Code: cav40  
Total width: 243 cm  
Total depth: 94 cm

Cave Sofa | 3,5 seater



Code: cav168  
Total width: 273 cm  
Total depth: 94 cm

Cave Sofa | 2,5 seater Arm Left/Right



Code: cav31/cav32  
Total width: 182 cm  
Total depth: 94 cm

Cave Sofa | 3 seater Arm Left/Right



Code: cav36/cav37  
Total width: 212 cm  
Total depth: 94 cm

Cave Lounge Chair | 1 seater

Upholstery Group A  
Upholstery Group B  
Upholstery Group C  
Upholstery Group D

Cave Sofa | 2,5 seater

Upholstery Group A  
Upholstery Group B  
Upholstery Group C  
Upholstery Group D

Cave Sofa | 3 seater

Upholstery Group A  
Upholstery Group B  
Upholstery Group C  
Upholstery Group D

Cave Sofa | 3,5 seater

Upholstery Group A  
Upholstery Group B  
Upholstery Group C  
Upholstery Group D

Cave Sofa | 2,5 seater Arm Left/Right

Upholstery Group A  
Upholstery Group B  
Upholstery Group C  
Upholstery Group D

Cave Sofa | 3 seater Arm Left/Right

Upholstery Group A  
Upholstery Group B  
Upholstery Group C  
Upholstery Group D

Seating

Upholstery | see all fabric options on page 182

Frame

Steel | 9005, 9016 | see all options on page 185

# Sofas & Lounge Chairs

## Cave

### Cave Sofa | Corner Element

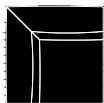

Code: cav92  
Total width: 94 cm  
Total depth: 94 cm

### Cave Sofa | Chaise Longue Arm Left/Right

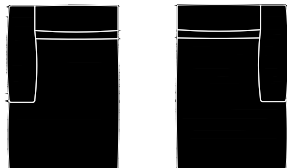

Code: cav41/cav42  
Total width: 106 cm  
Total depth: 160 cm

### Cave Sofa | Corner Element Platform Left/Right

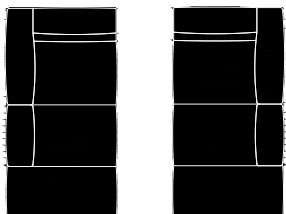

Code: cav24/cav23  
Total width: 96 cm  
Total depth: 210 cm

### Cave Sofa | Lounge Element Left/Right

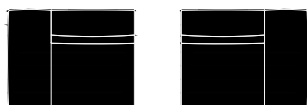

Code: cav01/cav02  
Total width: 125 cm  
Total depth: 94 cm

### Cave | Hocker



Code: cav50  
Total width: 90 cm  
Total depth: 97 cm  
Total height: 47 cm

### Cave Sofa | Corner Element

Upholstery Group A  
Upholstery Group B  
Upholstery Group C  
Upholstery Group D

### Cave Sofa | Chaise Longue Arm Left/Right

Upholstery Group A  
Upholstery Group B  
Upholstery Group C  
Upholstery Group D

### Cave Sofa | Corner Element Platform Left/Right

Upholstery Group A  
Upholstery Group B  
Upholstery Group C  
Upholstery Group D

### Cave Sofa | Lounge Element Left/Right

Upholstery Group A  
Upholstery Group B  
Upholstery Group C  
Upholstery Group D

### Cave | Hocker

Upholstery Group A  
Upholstery Group B  
Upholstery Group C  
Upholstery Group D

## Seating

Upholstery | see all fabric options on page 182

## Frame

Steel | 9005, 9016 | see all options on page 185



## Sofas & Lounge Chairs

Cosy

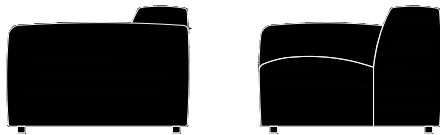
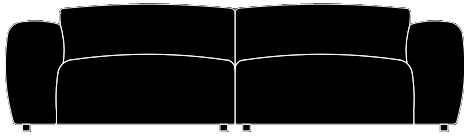
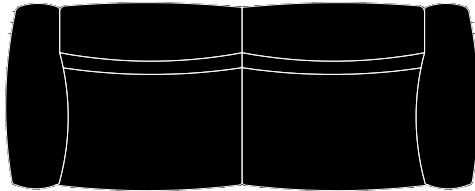

The Cosy is a voluptuous sofa that invites you to slow down, rest, restore, laugh and play. The soft shapes of the sofa make you want to never get up again. The modular sofa consists of different elements that you can combine in any way you desire.

Rather than picking a sofa, you pick each element you would like to have. The elements have different shapes, allowing you to really get creative with the design. What about a sofa in the shape of a half circle?

Total depth: 97 cm

Total height: 70 cm

Seat depth: 62 cm

Seat height: 46 cm

Arm width: 26 cm

Arm height: 61 cm

Material construction: fiber board / pine framework / hardwood

Seat suspension: nosag / polypropylene 70 g / m<sup>2</sup>

Material back: cold foam T18 foam a mix of feathers and silicone fibers covered with a layer of 300 g / m<sup>2</sup> dacron

Material seat: cold foam HR3032 with a mix of feathers and silicone fibers covered with a layer of 300 g / m<sup>2</sup> dacron

Material legs: plastic

Frame finish: black

Upholstery | see all fabric options on page 182

# Sofas & Lounge Chairs

Cosy

Cosy Lounge Chair | 1 seater

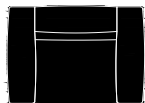

Code: cos15

Total width: 134 cm

Total depth: 97 cm

Cosy Sofa | 1,5 seater

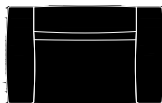

Code: cos20

Total width: 144 cm

Total depth: 97 cm

Cosy Sofa | 1 seater Arm Left/Right



Code: cos16/cos17

Total width: 107 cm

Total depth: 97 cm

Cosy Sofa | 1,5 seater Arm Left/Right



Code: cos21/cos22

Total width: 117 cm

Total depth: 97 cm

Cosy Sofa | 1 seater Middle Element

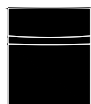

Code: cos13

Total width: 80 cm

Total depth: 97 cm

Cosy Sofa | 1,5 seater Middle Element



Code: cos14

Total width: 90 cm

Total depth: 97 cm

Cosy Lounge Chair | 1 seater

Upholstery Group A

Upholstery Group B

Upholstery Group C

Upholstery Group D

Cosy Sofa | 1,5 seater

Upholstery Group A

Upholstery Group B

Upholstery Group C

Upholstery Group D

Cosy Sofa | 1 seater Arm Left/Right

Upholstery Group A

Upholstery Group B

Upholstery Group C

Upholstery Group D

Cosy Sofa | 1,5 seater Arm Left/Right

Upholstery Group A

Upholstery Group B

Upholstery Group C

Upholstery Group D

Cosy Sofa | 1 seater Middle Element

Upholstery Group A

Upholstery Group B

Upholstery Group C

Upholstery Group D

Cosy Sofa | 1,5 seater Middle Element

Upholstery Group A

Upholstery Group B

Upholstery Group C

Upholstery Group D

Seating

Upholstery | see all fabric options on page 182

# Sofas & Lounge Chairs

Cosy

Cosy Sofa | Corner Element 90 Degrees

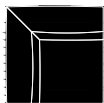

Code: cos92

Total width: 97 cm

Total depth: 97 cm

Cosy Sofa | Corner Element 45 Degrees



Code: cos45

Total width: 112 cm

Total depth: 97 cm

Cosy Sofa | Chaise Longue Arm Left/Right

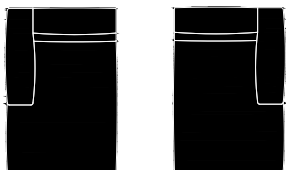

Code: cos41/cos42

Total width: 112 cm

Total depth: 137 cm

Cosy Sofa | Corner Element Platform Left/Right

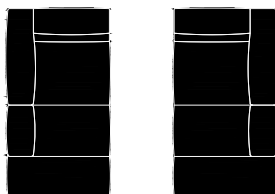

Code: cos24/cos23

Total width: 97 cm

Total depth: 190 cm

Cosy Sofa | Lounge Element Left/Right



Code: cos01/cos02

Total width: 130 cm

Total depth: 97 cm

Cosy | Hocker



Code: cos50

Total width: 90 cm

Total depth: 97 cm

Total height: 42 cm

Cosy Sofa | Corner Element 90 Degrees

Upholstery Group A

Upholstery Group B

Upholstery Group C

Upholstery Group D

Cosy Sofa | Corner Element 45 Degrees

Upholstery Group A

Upholstery Group B

Upholstery Group C

Upholstery Group D

Cosy Sofa | Chaise Longue Arm Left/Right

Upholstery Group A

Upholstery Group B

Upholstery Group C

Upholstery Group D

Cosy Sofa | Corner Element Platform Left/Right

Upholstery Group A

Upholstery Group B

Upholstery Group C

Upholstery Group D

Cosy Sofa | Lounge Element Left/Right

Upholstery Group A

Upholstery Group B

Upholstery Group C

Upholstery Group D

Cosy | Hocker

Upholstery Group A

Upholstery Group B

Upholstery Group C

Upholstery Group D

Seating

Upholstery | see all fabric options on page 182

## Sofas & Lounge Chairs

Layer

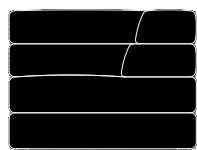
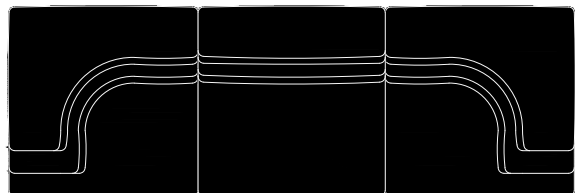

The Layer Sofa is a 70's inspired design with a contemporary twist. Each element of this statement sofa is built from identical base pieces that can be assembled in a 360° modular layout. The layers are not only a prominent feature of its aesthetic, but also play a part in the functionality of this piece. Its internal elements include a 'layering' of different materials such as a combination of woods, cold foam and nosag springs that contribute to the Layer Sofa's strength and comfort. With this sofa you can really sit back, relax and enjoy the soft gradients of luxurious layers while experiencing the comfort and strength of this unique design.

Total depth: 100/170 cm

Total height: 75 cm

Seat depth: 60 cm

Seat height: 40 cm

Arm width: 25/40 cm

Arm height: 75 cm

Material construction: fiber board / pine framework / hardwood

Seat suspension: nosag

Material back: cold foam T20 covered with a layer of 100 g / m<sup>2</sup> dacron

Material seat: cold foam HR35 covered with a layer of 200 g / m<sup>2</sup> dacron

Material legs: plastic

Frame finish: black

Upholstery | see all fabric options on page 182

# Sofas & Lounge Chairs

Layer

Layer Sofa | 1 seater Arm Left/Right



Code: LAYE93SO/94SO

Total width: 100 cm

Total depth: 100 cm

Layer Sofa | 1,5 seater Middle Element



Code: LAYE14SO

Total width: 100 cm

Total depth: 100 cm

Layer Sofa | 1 seater Corner Element

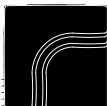

Code: LAYE92SO

Total width: 100 cm

Total depth: 100 cm

Layer Sofa | 1,5 seater Open Corner Element



Code: LAYE95SO

Total width: 100 cm

Total depth: 100 cm

Layer Sofa | Hocker



Code: LAYE50SO

Total width: 100 cm

Total depth: 100 cm

Layer Sofa | Chaise Longue Arm Left/Right

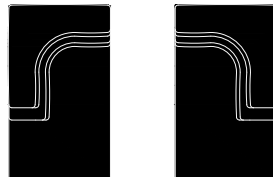

Code: LAYE41SO/LAYE42SO

Total width: 100 cm

Total depth: 170 cm

Layer Sofa | 1 seater Arm Left/Right

Upholstery Group A

Upholstery Group B

Upholstery Group C

Upholstery Group D

Layer Sofa | 1,5 seater Middle Element

Upholstery Group A

Upholstery Group B

Upholstery Group C

Upholstery Group D

Layer Sofa | 1 seater Corner Element

Upholstery Group A

Upholstery Group B

Upholstery Group C

Upholstery Group D

Layer Sofa | 1,5 seater Open Corner Element

Upholstery Group A

Upholstery Group B

Upholstery Group C

Upholstery Group D

Layer Sofa | Hocker

Upholstery Group A

Upholstery Group B

Upholstery Group C

Upholstery Group D

Layer Sofa | Chaise Longue Arm Left/Right

Upholstery Group A

Upholstery Group B

Upholstery Group C

Upholstery Group D

Seating

Upholstery | see all fabric options on page 182

# Poufs

Otto

Otto | S

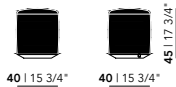

Otto | L



Otto | S

Upholstery Group A

Upholstery Group B

Upholstery Group C

Upholstery Group D

Otto | L

Upholstery Group A

Upholstery Group B

Upholstery Group C

Upholstery Group D

Seating

Upholstery | see all fabric options on page 182

Base

Oak | see all finish options on page 183

# Lighting

## Nod Collection

Nod Pendant Lamp | M

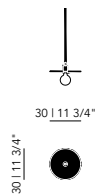

Nod Pendant Lamp | L

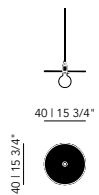

Nod Pendant Lamp | XL

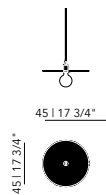

Nod Floor Lamp | L

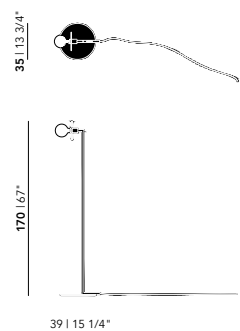

Nod Pendant Lamp

Model

M

L

XL

Nod Floor Lamp

Model

L

Light bulb excluded

Frame

Steel | Powdercoating | black RAL 9005

# Outdoor Collection

## Dining Tables

standard



Elements\*



Butterfly



New Classic



Slim X-type

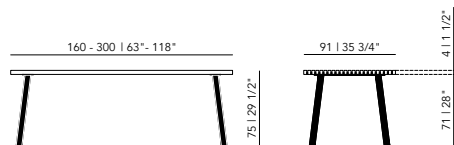
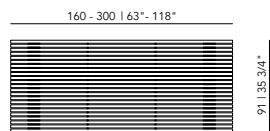

### Tabletop

Iroko | untreated

Accoya | untreated

### Frame

Steel | see all finish options on page 185

\*Iroko | untreated

\*Accoya | untreated

### Elements

Length (cm)	Width (cm)	Thickness (cm)	Height (cm)
160	91	4	75
180	91	4	75
200	91	4	75
220	91	4	75
240	91	4	75
260	91	4	75
280	91	4	75
300	91	4	75

### Butterfly | New Classic | Slim X-Type

Length (cm)	Width (cm)	Thickness (cm)	Height (cm)
160	91	4	75
180	91	4	75
200	91	4	75
220	91	4	75
240	91	4	75
260	91	4	75
280	91	4	75
300	91	4	75



# Outdoor Collection

## Dining Benches



Elements Bench\*

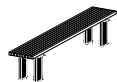

Butterfly Bench

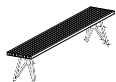

New Classic Bench



Slim X-type Bench

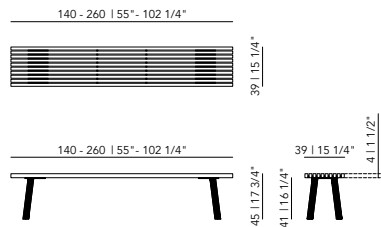

## Elements

Length (cm)	Width (cm)	Thickness (cm)	Height (cm)
140	39	4	45
160	39	4	45
180	39	4	45
200	39	4	45
220	39	4	45
240	39	4	45
260	39	4	45

## Butterfly | New Classic | Slim X-Type

Length (cm)	Width (cm)	Thickness (cm)	Height (cm)
140	39	4	45
160	39	4	45
180	39	4	45
200	39	4	45
220	39	4	45
240	39	4	45
260	39	4	45

### Tabletop

Iroko | untreated

Accoya | untreated

### Frame

Steel | see all finish options on page 185

\*Iroko | untreated

\*Accoya | untreated

# Outdoor Collection

## Dining Bench Cushions

### Dining Bench Cushion | Straight Corners

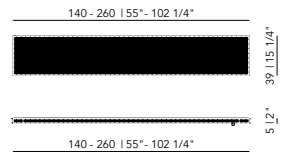

### Upholstery Group C | Sunbrella Heritage

Length (cm)	Width (cm)	Thickness (cm)
140	40	5
160	40	5
180	40	5
200	40	5
220	40	5
240	40	5
260	40	5

Upholstery

Sunbrella Heritage | 47% Sunbrella Acrylic, 50% Recycled

# Outdoor Sofas

## Element Outdoor Lounge

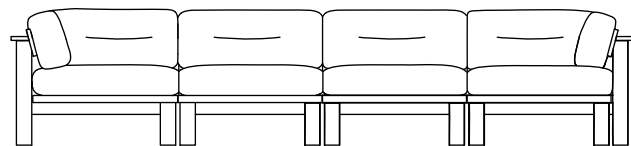
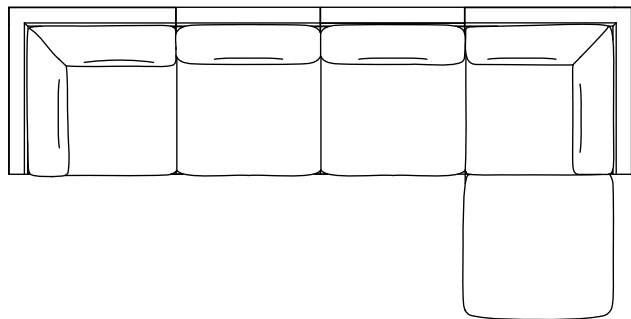

Luxury meets outdoor living with the Elements Outdoor Lounge. From lush gardens to city terraces, the Elements Outdoor Lounge will surely be the centrepiece of every outdoor space with its embodiment of ultimate relaxation and comfort. Make the lounge your own - choose from corner, middle, and hocker elements. Thanks to its interchangeable elements, the lounge can host all of your memorable moments this summer season, from solo morning coffees to afternoon refreshments for two and after-dinner nightcaps for many.

Total depth: 75/87 cm

Total width: 75/87 cm

Total height without cushion: 61 cm

Total height with cushion: 69 cm

Seat depth without cushion: 75 cm

Seat depth with cushion: 56 cm

Seat height without cushion: 26 cm

Seat height with cushion: 38,5 cm

Material construction: FSC certified iroko wood

Material back- & armrest cushions: cold foam 9018 covered with a layer of 200 g / m<sup>2</sup> dacron

Material seat cushion: cold foam 9515 covered with a layer of 200 g / m<sup>2</sup> dacron

Frame finish: untreated

Upholstery cushions: Sunbrella Heritage

# Outdoor Sofas

## Element Outdoor Lounge

### Element Lounge | Corner element

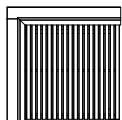

Code: ELEMORSOOC

Total width: 87 cm

Total depth: 87 cm

### Element Lounge | Hocker



Code: ELEMHOCSOOC

Total width: 75 cm

Total depth: 75 cm

Total height: 26 cm

### Element Lounge | Middle element

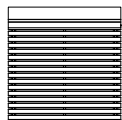

Code: ELEMIDSOOC

Total width: 75 cm

Total depth: 87 cm

### Element Lounge | Coffee table



Code: ELEMCTOC

Total width: 75 cm

Total depth: 75 cm

Total height: 26 cm

Element Outdoor Lounge	Code
Corner element	ELEMORSOOC
Middle element	ELEMIDSOOC
Hocker	ELEMHOCSOOC
Coffee table	ELEMCTOC

Element Outdoor Lounge   Cushions	Code
Seat cushion	ELEMSEATCUOC
Backrest cushion	ELEMBACKCUOC
Corner cushions (set)	ELEMBACKCORCUOC

Seating

Upholstery | Sunbrella Heritage

## Upholstery Groups

### Upholstery Group A

Andermaat | 100% polyester

Bear | 100% polyester

Cube | 100% polyester

Juke | 100% polyester

Olbia | 65% recycled cotton, 30% polyester, 5% recycled other fabrics

### Upholstery Group B

Regain | 100% recycled pet bottles

Soil | 60% recycled pet bottles, 40% polyester

Brema | 39% polyacryl, 39% polyester, 14% cotton, 8% wool

Facet | 70% recycled wool, 25% recycled polyamid, 5% recycled other fabrics

Royal | 100% polyester

### Upholstery Group C

Camira Oceanic | 100% post-consumer recycled polyester, including 50% SEAQUAL yarn

Kvadrat Re-wool | 45% recycled wool, 45% new wool worsted, 10% nylon

Kvadrat Hallingdal 65 | 70% new wool, 30% viscose

Kvadrat Steelcut 2 | 90% new wool worsted, 10% nylon

Kvadrat Steelcut Trio 3 | 90% new wool worsted, 10% nylon

Kvadrat Tonica 2 | 100% new wool

Kvadrat Tonus | 90% new wool, 10% helanca

Sunbrella Heritage | 50% recycled Sunbrella acrylic, 50% Sunbrella acrylic

### Upholstery Group D

Camira Hemp | 60% new wool, 40% true hemp

Kvadrat Divina 3 | 100% new wool

Kvadrat Twill Weave | 90% new wool worsted, 10% nylon

Rancho | 100% leather

Toledo | 100% leather

Verve | 100% leather

## Finish Options

### Wood | finish options

#### Oak hardwax oil natural light | 3041

A natural treatment with a very light whitewash. This prevents yellowing in the long term. Hardwax oil is, in contrast to lacquer, less scratch-sensitive and protects against stains.

#### Oak hardwax oil natural | 3062

A natural treatment. This treatment is somewhat warmer or yellow-toned than the hardwax oil natural light 3041. Hardwax oil is, in contrast to lacquer, less scratch-sensitive and protects against stains.

#### Oak black stain | 9017

A stain finish with a black look. The stain is covered with a clear two-component lacquer. Lacquer is more sensitive to scratches than hardwax oil. This lacquer protects well against stains.

#### Oak smoked stain | 0002

A stain finish with a smoked look. The stain is covered with a clear two-component lacquer. Lacquer is more sensitive to scratches than hardwax oil. This lacquer protects well against stains.

#### Oak black lacquer | 9005

A two-component lacquer finish with the colour RAL 9005. Lacquer is more sensitive to scratches than hardwax oil. This lacquer protects well against stains. This finish is not recommended for dining tables.

#### Oak white lacquer | 9016

A two-component lacquer finish with the colour RAL 9016. Lacquer is more sensitive to scratches than hardwax oil. This lacquer protects well against stains. This finish is not recommended for dining tables.

#### Walnut natural lacquer | 0001

A two-component lacquer finish with a natural look. Lacquer is more sensitive to scratches than hardwax oil. This lacquer protects well against stains.

#### Amoeba natural lacquer | 0004

A two-component lacquer finish with a natural look. Lacquer is more sensitive to scratches than hardwax oil. This lacquer protects well against stains.

#### Amoeba black lacquer | 0005

A two-component lacquer finish with a natural look. Lacquer is more sensitive to scratches than hardwax oil. This lacquer protects well against stains.

### HPL Fenix | finish options

Applicable for dining tabletops and dining bench seats.

A very solid plate consisting of several layers of compressed wood fiber. Fenix NTM's nanotechnology creates a very matt and silky smooth surface. It is resistant to rubbing, and minor scratching and wear. Available for tabletops and dining benches in Studio HENK's selection of colours.

Fenix NTM | 0029 Bianco Malè

Fenix NTM | 0030 Bianco Alaska

Fenix NTM | 0032 Bianco Kos

Fenix NTM | 0719 Beige Luxor

Fenix NTM | 0717 Castoro Ottowa

Fenix NTM | 0718 Grigio Londra

Fenix NTM | 0724 Grigio Bromo

Fenix NTM | 0725 Grigio Efeso

Fenix NTM | 0748 Beige Arizona

Fenix NTM | 0749 Cacao Orinoco

Fenix NTM | 0750 Verde Comodoro

Fenix NTM | 0751 Rosso Jaipur

Fenix NTM | 0752 Grigio Antrim

Fenix NTM | 0754 Blu Fes

Fenix NTM | 0720 Nero Ingo

### Steel | finish options

Applicable for dining tables, dining benches, coffee tables, dining chairs, stools, sofas, cabinets, lighting.

#### Powdercoating | black RAL 9005

Powdercoating is a hard finish, tougher than conventional paint.

#### Powdercoating | white RAL 9016

Powdercoating is a hard finish, tougher than conventional paint.

### Edge | finish options

Standard



Chamfered



# How many chairs fit a dining table

## Rectangular

The chair used in the example has a width of 46,5 cm. The frames of rectangular tables can be positioned 14 (A), 20 (B) or 26 (C) cm from the sides. The exact space between the frames depends on the type of table frame. The frames of the 350 and 400 cm tables have a fixed position. You do not have to decide on the positioning when you purchase the table. All mounting positions are already in the tabletop so you can always change the position yourself.

### 160 cm | 63"

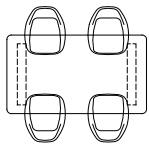

122 cm | 46 1/2"  
Frame position A

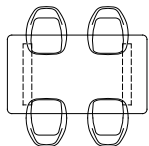

110 cm | 43 1/4"  
Frame position B

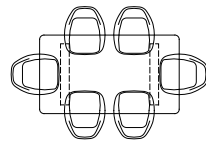

98 cm | 38 1/2"  
Frame position C

### 180 cm | 70 3/4"

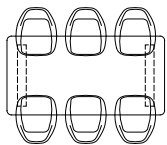

142 cm | 56"  
Frame position A

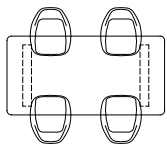

130 cm | 51 1/4"  
Frame position B

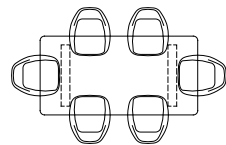

118 cm | 46 1/2"  
Frame position C

### 200 cm | 78 3/4"

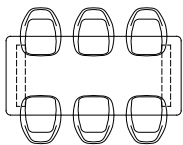

162 cm | 63 3/4"  
Frame position A

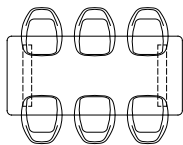

150 cm | 59"  
Frame position B

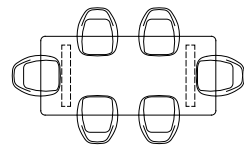

138 cm | 54 1/4"  
Frame position C

### 220 cm | 86 1/2"

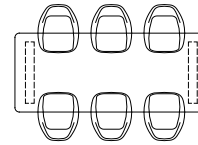

182 cm | 71 3/4"  
Frame position A

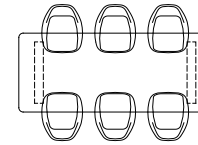

170 cm | 67"  
Frame position B

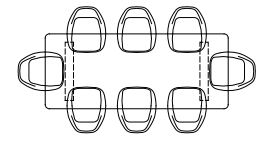

158 cm | 62 1/4"  
Frame position C

### 240 cm | 94 1/2"

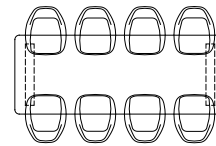

204 cm | 79 1/2"  
Frame position A

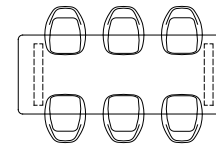

190 cm | 74 3/4"  
Frame position B

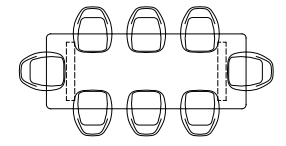

178 cm | 70"  
Frame position C

### 260 cm | 102 1/4"

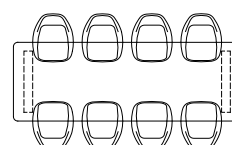

222 cm | 87 1/2"  
Frame position A

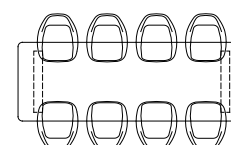

210 cm | 82 3/4"  
Frame position B

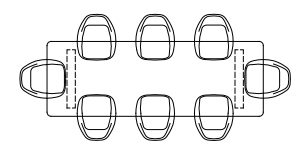

198 cm | 78"  
Frame position C

### 280 cm | 110 1/4"

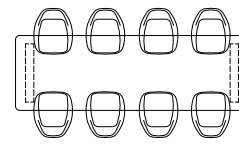

242 cm | 95 1/4"  
Frame position A

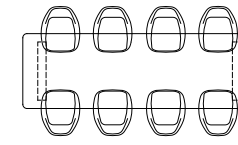

230 cm | 90 1/2"  
Frame position B

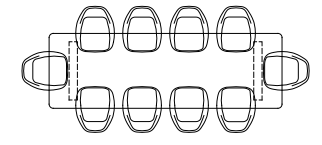

218 cm | 85 3/4"  
Frame position C

300 cm | 118"

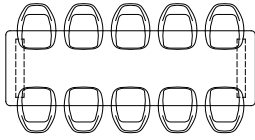

262 cm | 103 1/4"  
Frame position A

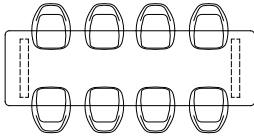

250 cm | 98 1/2"  
Frame position B

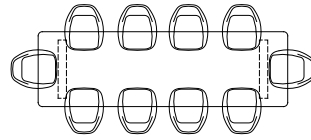

238 cm | 93 3/4"  
Frame position C

350 cm | 137 3/4"

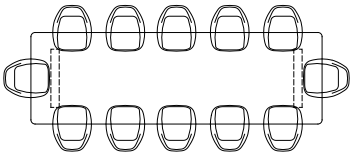

288 cm | 113 1/2"

400 cm | 157 1/2"

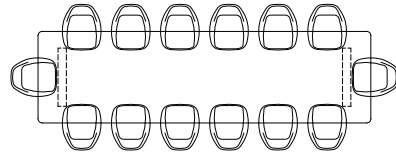

328 cm | 133"

## How many chairs fit a dining table

### Flat oval

The chair used in the example has a width of 46,5 cm. The frames of flat oval tables can be positioned 39 (A), 43 (B) or 49 (C) cm from the sides. The exact space between the frames depends on the type of table frame. The frames of the 350 and 400 cm tables have a fixed position. You do not have to decide on the positioning when you purchase the table. All mounting positions are already in the tabletop so you can always change the position yourself.

200 cm | 78 3/4"

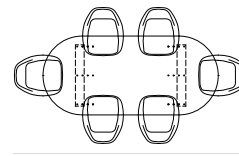

106 cm | 71 3/4"  
Frame position A

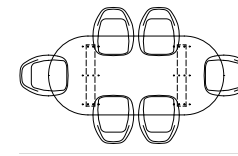

94 cm | 37"  
Frame position B

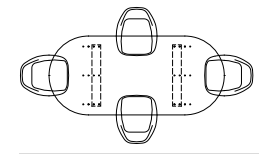

82 cm | 32 1/4"  
Frame position C

220 cm | 86 1/2"

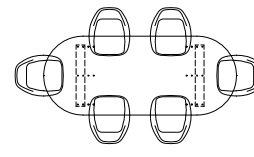

126 cm | 49 1/2"  
Frame position A

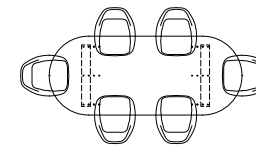

114 cm | 45"  
Frame position B

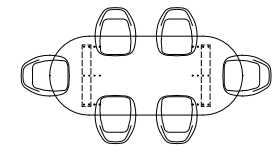

102 cm | 40 1/4"  
Frame position C

240 cm | 94 1/2"

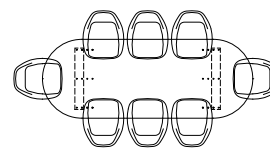

146 cm | 57 1/2"  
Frame position A

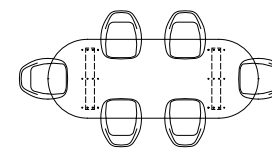

134 cm | 52 3/4"  
Frame position B

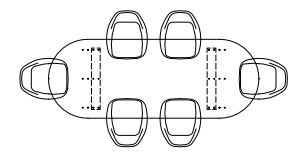

122 cm | 48"  
Frame position C



260 cm | 102 1/4"

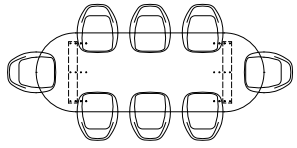

166 cm | 65 1/4"  
Frame position A

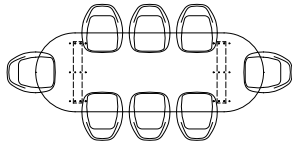

154 cm | 60 3/4"  
Frame position B

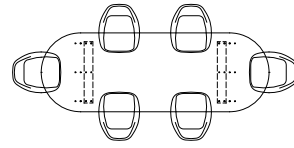

142 cm | 56"  
Frame position C

280 cm | 110 1/4"

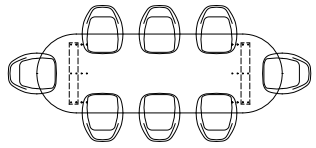

186 cm | 73 1/4"  
Frame position A

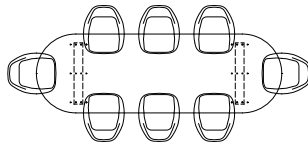

174 cm | 68 1/2"  
Frame position B

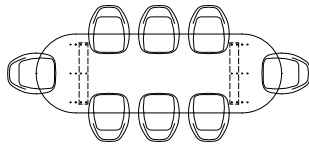

162 cm | 63 3/4"  
Frame position C

300 cm | 118"

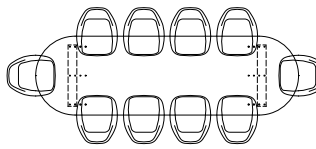

206 cm | 81"  
Frame position A

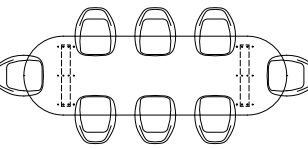

194 cm | 76 1/2"  
Frame position B

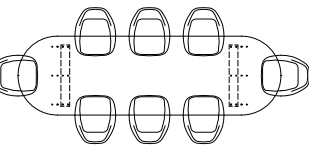

182 cm | 71 3/4"  
Frame position C

350 cm | 137 3/4"

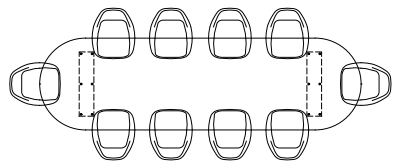

232 cm | 91 1/4"

400 cm | 157 1/2"

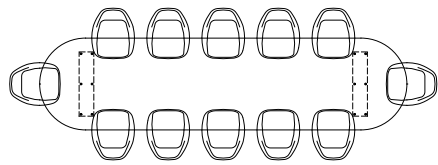

282 cm | 111"

## How many chairs fit a dining table

Oval

The chair used in the example has a width of 46,5 cm. The frames of oval tables can be mounted on two positions. The exact space between the frames depends on the type of table frame.

200 cm | 78 3/4"

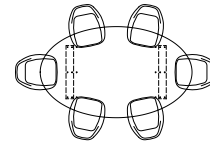

122 cm | 48"  
Frame position A

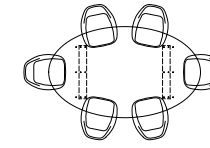

110 cm | 43 1/4"  
Frame position B

220 cm | 86 1/2"

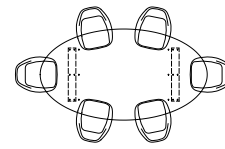

136 cm | 53 1/2"  
Frame position A

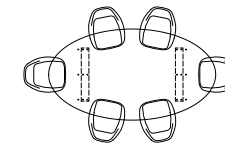

124 cm | 48 3/4"  
Frame position B

240 cm | 94 1/2"

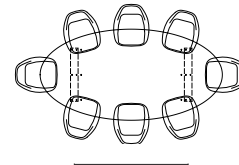

150 cm | 59"  
Frame position A

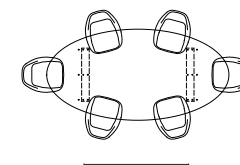

138 cm | 54 1/4"  
Frame position B

260 cm | 102 1/4"

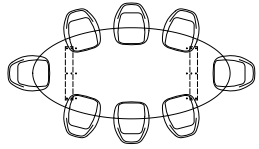

164 cm | 64 1/2"  
Frame position A

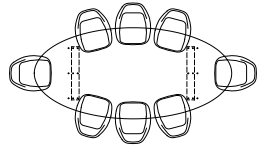

152 cm | 59 3/4"  
Frame position B

280 cm | 110 1/4"

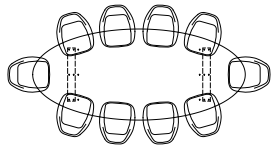

178 cm | 70"  
Frame position A

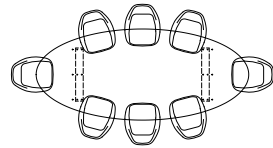

166 cm | 65 1/5"  
Frame position B

300 cm | 118"

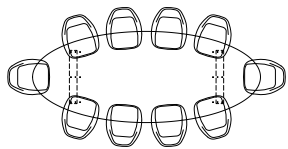

193 cm | 76"  
Frame position A

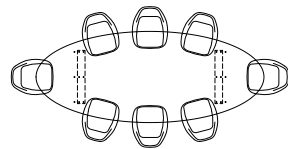

181 cm | 71 1/4"  
Frame position B

350 cm | 137 3/4"

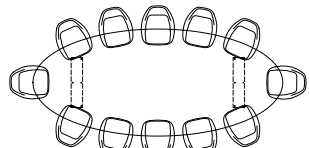

230 cm | 90 1/2"

400 cm | 157 1/2"

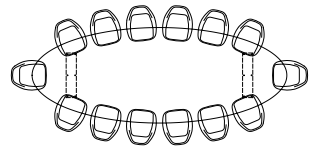

277 cm | 109"

## How many chairs fit a dining table

### Blob

The chair used in the example has a width of 46,5 cm. The frames of blob tables can be mounted on three positions. The exact space between the frames depends on the type of table frame.

200 cm | 78 3/4"

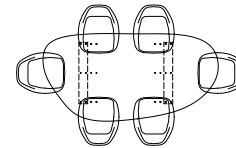

109 cm | 38 1/4"  
Frame position A

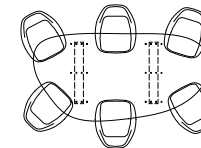

97 cm | 33 1/2"  
Frame position B

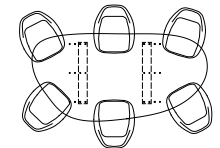

85 cm | 28 3/4"  
Frame position C

220 cm | 86 1/2"

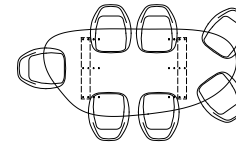

122 cm | 43 1/4"  
Frame position A

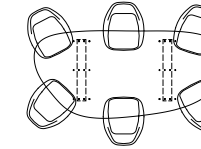

110 cm | 38 1/2"  
Frame position B

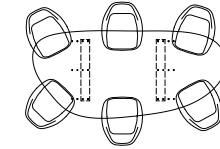

98 cm | 33 3/4"  
Frame position C

240 cm | 94 1/2"

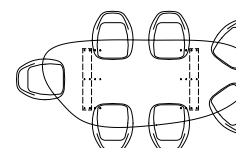

134 cm | 48"  
Frame position A

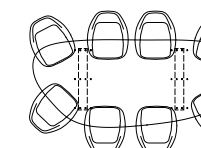

122 cm | 43 1/4"  
Frame position B

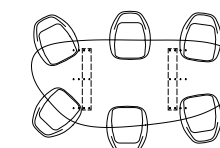

110 cm | 38 1/2"  
Frame position C

260 cm | 102 1/4"

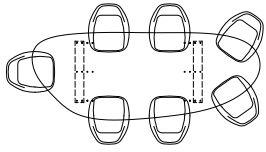

147 cm | 53 1/4"  
Frame position A

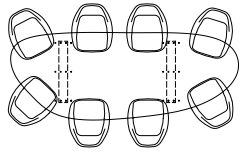

135 cm | 48 1/2"  
Frame position B

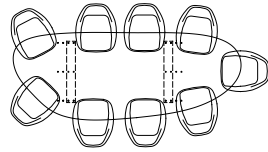

123 cm | 43 3/4"  
Frame position C

280 cm | 110 1/4"

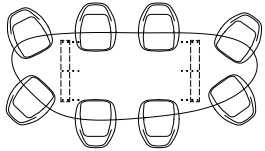

160 cm | 58 1/4"  
Frame position A

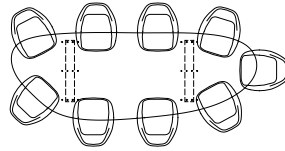

148 cm | 53 1/2"  
Frame position B

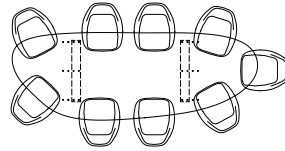

136 cm | 48 3/4"  
Frame position C

300 cm | 118"

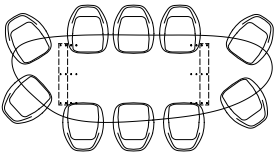

173 cm | 63 1/2"  
Frame position A

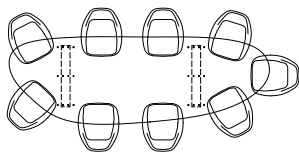

161 cm | 58 3/4"  
Frame position B

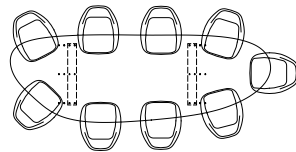

149 cm | 54"  
Frame position C

350 cm | 137 3/4"

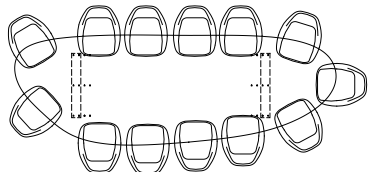

206 cm | 81"

400 cm | 157 1/2"

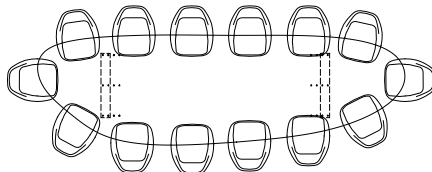

239 cm | 94"

## How many chairs fit a dining table

Round

The chair used in the example has a width of 46,5 cm. The frames of the round tables have a fixed position.

100 cm | 39 1/4"



110 cm | 43 1/4"

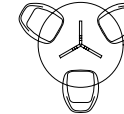

120 cm | 47 1/4"

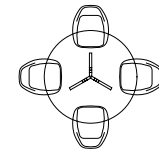

130 cm | 51 1/4"

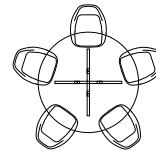

140 cm | 55"

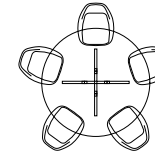

150 cm | 59"

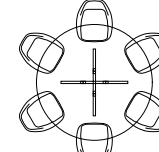

160 cm | 63"

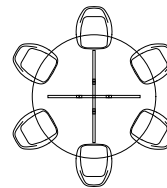

170 cm | 67"

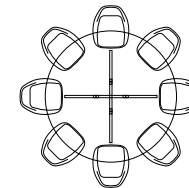

180 cm | 70 3/4"

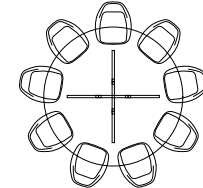

[www.studio-henk.nl](http://www.studio-henk.nl)

CONTACT

[info@studio-henk.nl](mailto:info@studio-henk.nl)

+31 (0)20 233 38 20

[facebook.com/studiohenk](https://facebook.com/studiohenk)

[instagram.com/studiohenk](https://instagram.com/studiohenk)

V18 May 2022

© 2022 Studio HENK. All rights reserved. Text and printing errors reserved.